





Bimetallic Thermometer, Back Mount

Model: MTB.S_BL



PRODUCT DESCRIPTION

▼
Stainless steel material, sturdy and durable

▼
Used in food and air conditioning industries, etc.

PRODUCT SPECIFICATION

Connection location
Back mount

Nominal size
1.5", 2", 2.5", 3", 4", 5", 6"

Scale ranges
-50°C ... 600°C

Accuracy
CL 1.0

Process connection
304 SS, 316 SS
1/8, 1/4, 3/8, 1/2, 3/4
PT, G, NPT, M

Sanitary end cap
1", 1 1/2", 2", 2 1/2", 3", 4"

Connection designs
Male thread, plain stem,
compression fitting (sliding on stem),
union nut and loose threaded connection,
male nut, union nut, sanitary end cap,
metallic sheet with dual hole,
flange on stem

Stem
304 SS, 316 SS
Length:
Above 40 mm (without thread)
can be customized
Diameter:
6, 6.35, 8, 9.5, 10 mm

Case/Ring
304 SS

Window
Glass, safety glass

Dial
Aluminum alloy
Black scale on white

Pointer
Black aluminum alloy

Filling liquid
Without, glycerine

Accessories (option)
Zero point setting with adjustment screw,
thermowell, adjustable set pointer,
drag pointer, spacer

Protection
IP67

DIMENSIONS

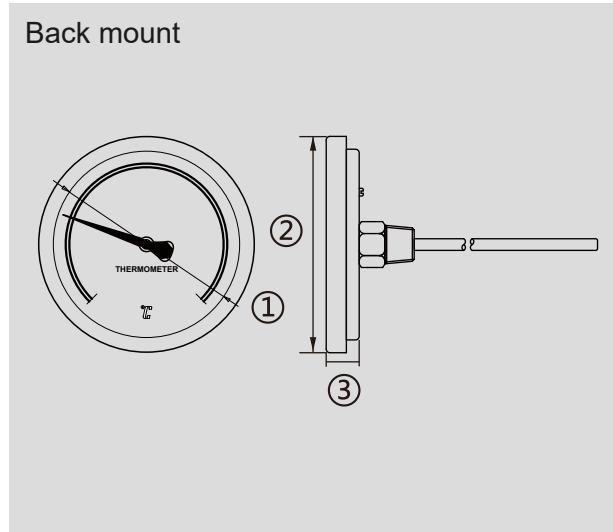

Dimensions (mm)			
NS	①	②	③
1.5"	34	45	16
2"	49	58	14
2.5"	57	66	15
3"	72	84	17
4"	101	119	18
5"	114	130	18
6"	140	160	18

CONNECTION DESIGN

Male thread

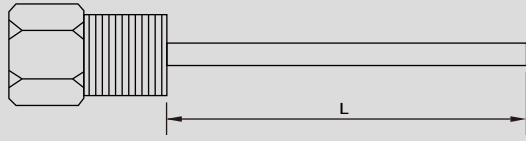

Plain stem

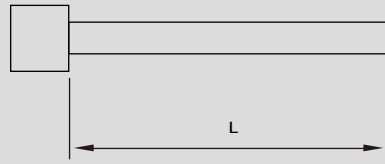

Compression fitting (sliding on stem)

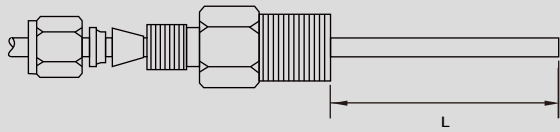

Union nut and loose threaded connection

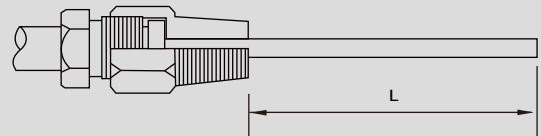

Male nut

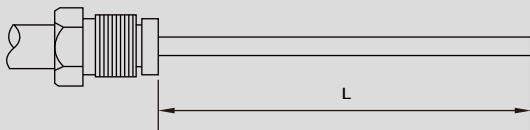

Union nut

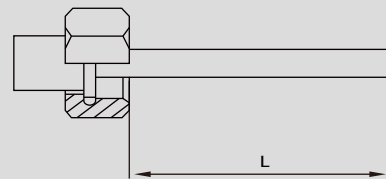

Sanitary end cap

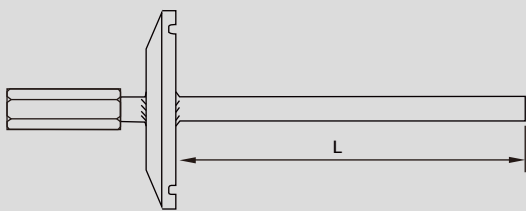

Flange on stem

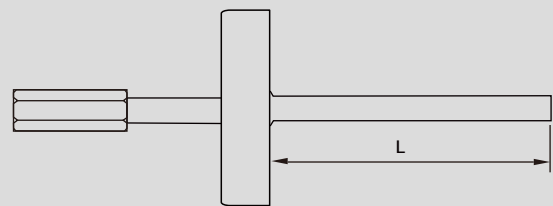

Metallic sheet with dual hole

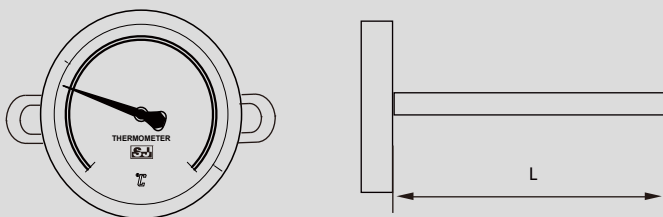

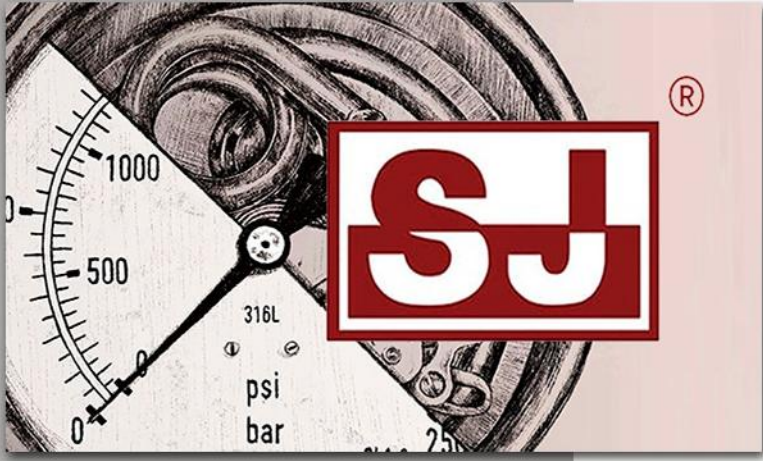

rsIMMA

Elementos For Manufacturing Processes



MEXICO BRANCH OFFICE

Roberto Diaz No. 401
Ciudad Industrial
Aguascalientes, Ags.
México
20290

4ManPro@4ManPro.com
+52 (449) 171 3420
www.4ManPro.com/SPA/

USA BRANCH OFFICE

708 Main St.
10th Floor
Houston, Tx, USA
77002

4ManPro_USA@4ManPro.com
+1 (832) 871 5022
www.4ManPro.com/ENG/

