



4ManPro

Elements For Manufacturing Processes



**SERVO
MOTORES
Serie
B2**



High Precision. High Response. Cost Effective.

The high-performance, cost-effective ASDA-B2 Series servo motors and drives meet the requirements for general-purpose machine control applications in the industrial automation market and enhance the competitive advantage of servo systems.

The power rating of the ASDA-B2 Series ranges from 0.1kW to 3kW. The superior features of this series emphasize built-in motion control functions for general purpose applications and saving the cost of mechatronics integration. Delta's ASDA-B2 makes setting assembly, wiring, and operation convenient. In switching from other brands to Delta's ASDA-B2, the outstanding quality and features, and complete product lineup makes replacement simple and scalable. Customers that choose this value-based product gain noticeable competitive advantages in their market space. All of Delta's ASDA-B2 Series meet UL, cUL, CE, and RoHS standards.

Transporting and Conveying Equipment

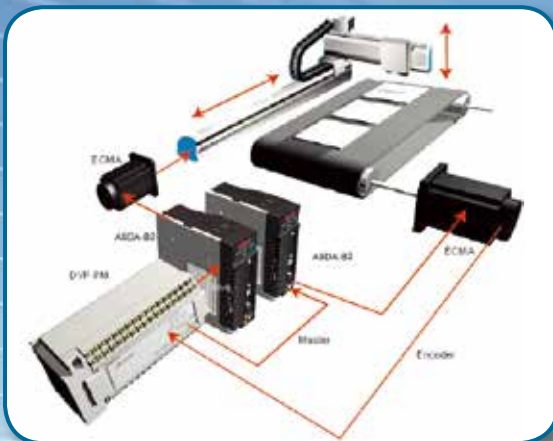

Electric Discharge Machines (EDM)



Cutting Machines

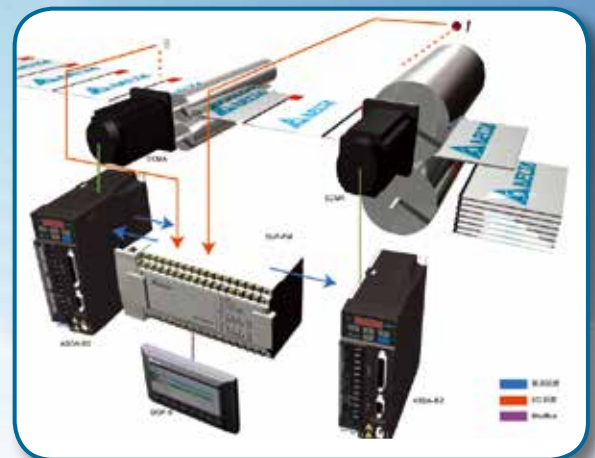

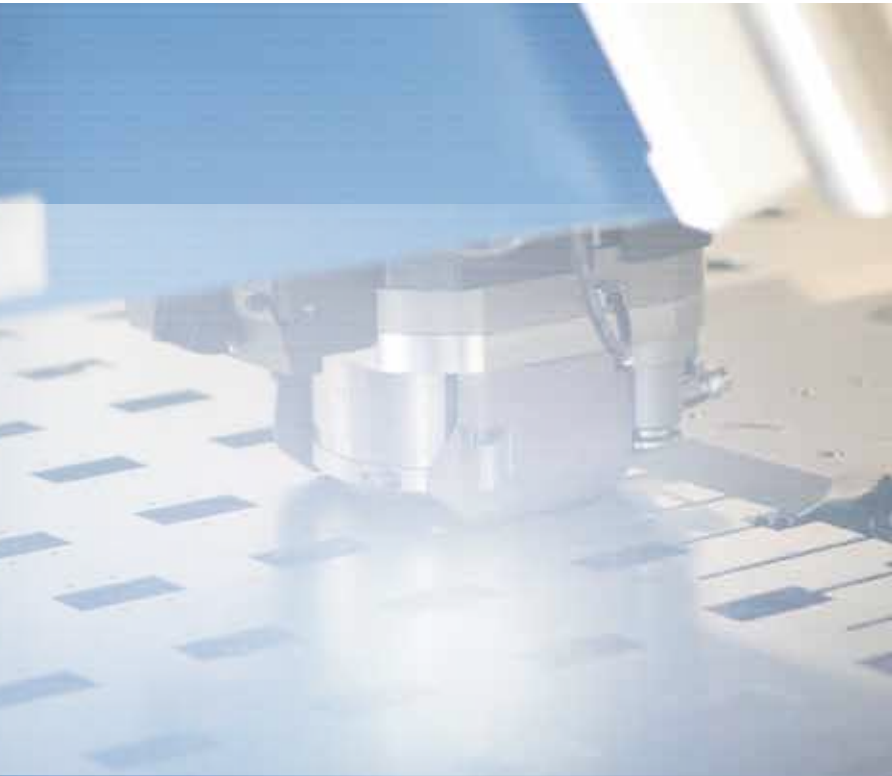

Sawing Machines



Table of Contents

| | |
|----|------------------------------------|
| 3 | Product Features |
| 5 | Model Name Explanation |
| 6 | Product Line-up |
| 7 | Part Names and Functions |
| 9 | Wiring |
| 12 | Selection of Regenerative Resistor |
| 12 | Safety Information |
| 13 | Servo Drive Specifications |
| 15 | Servo Drive Dimensions |
| 19 | Servo Motor Specifications |
| 23 | Servo Motor Dimensions |
| 23 | Speed-Torque Curve (T-N Curves) |
| 27 | Optional Accessories |
| 33 | Accessories Combinations |



Product Features

Implements High Precision Positioning Control

- ▶ ASDA-B2 Series servo drive supports 20-bit and 17-bit encoders. It satisfies the demand for high-precision positioning control and stable operation with lower speed.
- ▶ Applying the encoder with a higher resolution can reduce the cogging torque and improve the motor's precision.

2500ppr of Torque Ripple

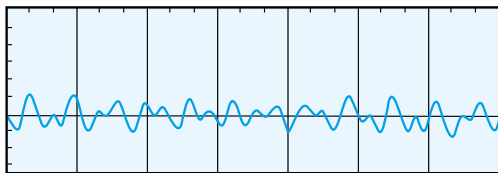

17-bit of Torque Ripple

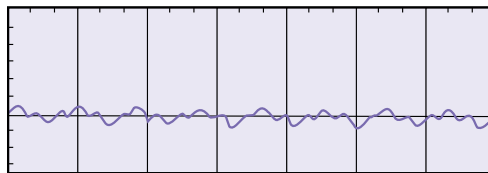

- ▶ Outstanding performance with higher speed: Up to 550Hz frequency response and settling time is below 1ms.
- ▶ 10ms acceleration time from -3000r/min to 3000r/min when running without a load.

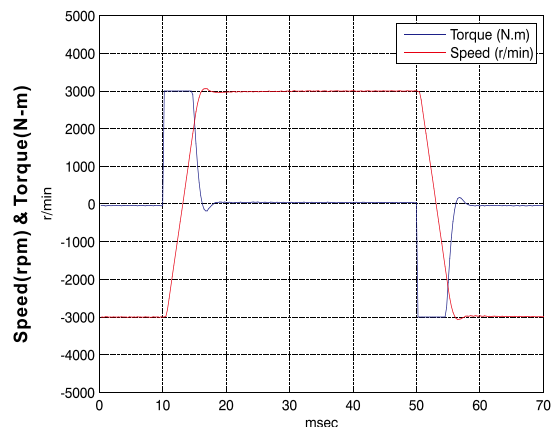
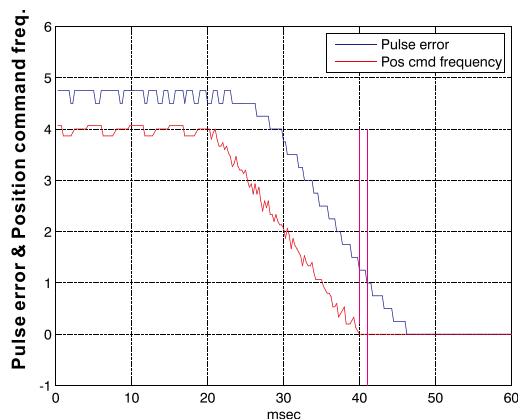

Example: Frame size 60mm and 400W servo motor.

Satisfies a Variety of Industry Requirements

- ▶ Three control modes available: Built-in position, Speed, and Torque. (Speed and Torque mode can be controlled by internal parameters or analog voltage.)
- ▶ High-speed differential command (up to 4Mpps) for high precision positioning control.
- ▶ Three notch filters are provided to suppress the mechanical resonance efficiently and make the system operate more smoothly.
- ▶ Lead friction compensation parameter is specified for the application of circular interpolation, Z-axis motion and ball screw, and others to reduce the loading of the controller.
- ▶ For bar feeders and other equipment requiring high torque output, motor protection parameters are offered to protect the mechanical system.

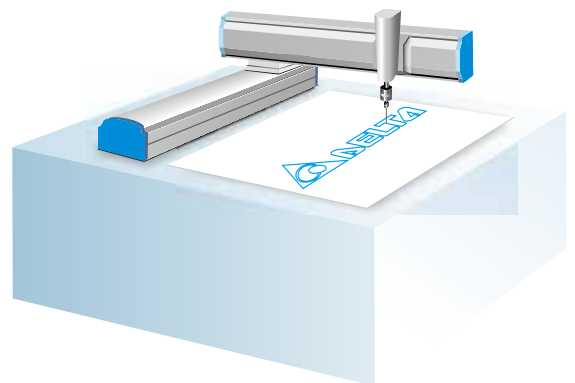

Offers Easy-To-Install Solution For Simple Start-Up

Separated power supply for main circuit and control circuit



- ▶ ASDA-B Series share the same power cables and encoder cables for easy installation and setup without extra accessories.
- ▶ Servo motor provides brake, oil seal, and other optional configurations for different applications.
- ▶ Separated power supply for main circuit and control circuit makes it easier to maintain the mechanism.
- ▶ 400W or above servo drives have built-in regenerative resistors, which simplify wiring and reduce the installation cost.
- ▶ Individual connectors (2 sets) for analog signal output, also simplifies the wiring.

MON1
MON2

Supports two analog outputs

Fulfills Easy-To-Use Requirements For Versatile Operation

- ▶ User-friendly motor sizing software allows users to select the motor.
- ▶ ASDA-Soft configuration software (tuning software) is provided to meet performance requirements quickly.
- ▶ Easy-to-use digital keypad is ideal for setting parameters and enables users to directly monitor the servo drive and servo motor.
- ▶ Specific software communication cable ASD-CNUS0A08 (Optional) can improve communication quality and convenience of operation. (please refer to optional accessories on page 28)

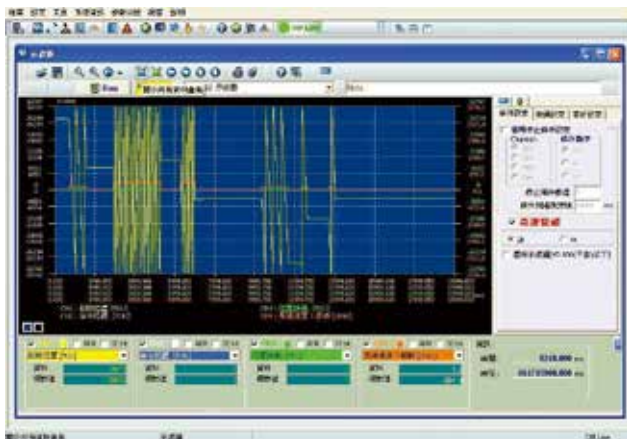
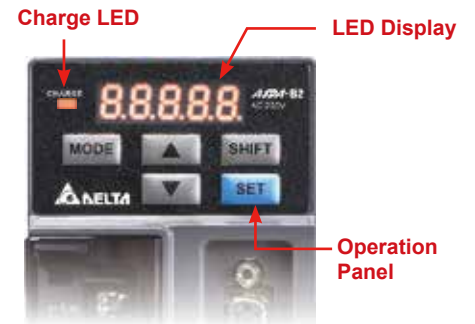

| 参数号 | 名称 | 数据类型 | 出厂值 | 范围 | 分辨率 | 备注 |
|-------|------|------|-----------|-----------------------|----------|---------------|
| PA_01 | 频率 | 频率 | 50.000000 | 0.000000~1000.000000 | 0.000000 | 最高运行频率 (Hz) |
| PA_02 | 加速 | 加速度 | 0.000000 | 0.000000~10000.000000 | 0.000000 | 最高加速 (Hz/s) |
| PA_03 | 减速 | 减速度 | 0.000000 | 0.000000~10000.000000 | 0.000000 | 最高减速 (Hz/s) |
| PA_04 | 速度 | 速度 | 0 | 0~1000 | 0.01 | 最高速度 (mm/s) |
| PA_05 | 位置 | 位置 | 0 | 0~100000 | 0.001 | 最高位置 (mm) |
| PA_06 | 速度反馈 | 速度反馈 | 0 | 0~10000 | 0.001 | 速度反馈增益 (mm/s) |
| PA_07 | 位置反馈 | 位置反馈 | 0 | 0~100000 | 0.001 | 位置反馈增益 (mm) |
| PA_08 | 速度反馈 | 速度反馈 | 0 | 0~10000 | 0.001 | 速度反馈增益 (mm/s) |
| PA_09 | 位置反馈 | 位置反馈 | 0 | 0~100000 | 0.001 | 位置反馈增益 (mm) |
| PA_10 | 速度反馈 | 速度反馈 | 0 | 0~10000 | 0.001 | 速度反馈增益 (mm/s) |
| PA_11 | 位置反馈 | 位置反馈 | 0 | 0~100000 | 0.001 | 位置反馈增益 (mm) |
| PA_12 | 速度反馈 | 速度反馈 | 0 | 0~10000 | 0.001 | 速度反馈增益 (mm/s) |
| PA_13 | 位置反馈 | 位置反馈 | 0 | 0~100000 | 0.001 | 位置反馈增益 (mm) |
| PA_14 | 速度反馈 | 速度反馈 | 0 | 0~10000 | 0.001 | 速度反馈增益 (mm/s) |
| PA_15 | 位置反馈 | 位置反馈 | 0 | 0~100000 | 0.001 | 位置反馈增益 (mm) |

- ▶ On-line monitoring function for 4 channels (similar to a digital oscilloscope) is available. The monitoring data can be 16-bit (4 channels) and 32-bit (2 channels).

- ▶ Multi-functional parameter editor enables users to edit, modify, upload/download and print desired parameters in real time.

Model Name Explanation

ASDA-B2 Series Servo Drives

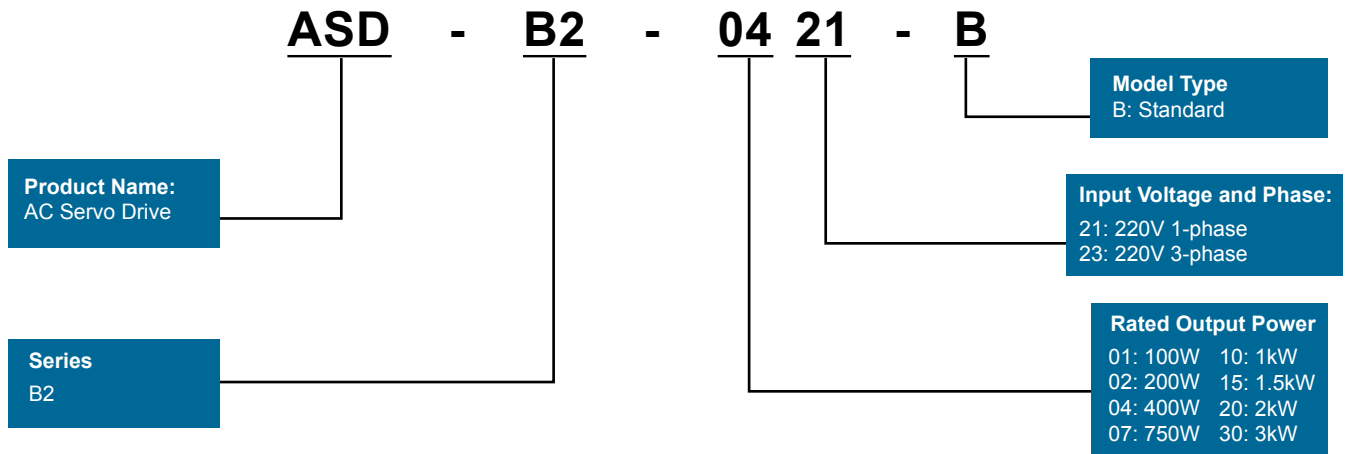

ECMA Series Servo Motors

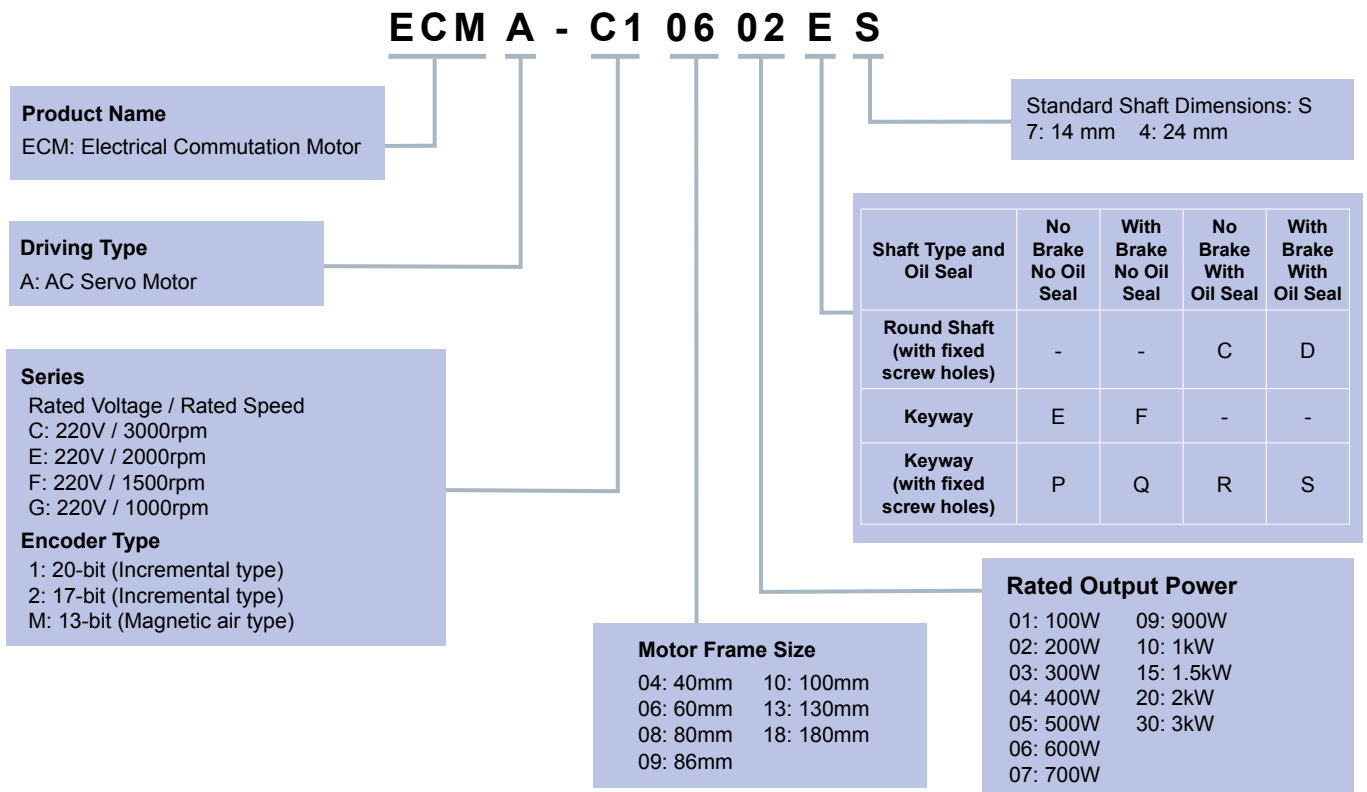

Product Line-up

| | | | | | | | | |
|--------------------|---|----------------|---|---------------|--|---------------|---|----------------|
| Servo Drive |  | |  | |  | |  | |
| | 0.1kW | 200W | 400W | 750W | 1.0kW | 1.5kW | 2kW | 3kW |
| | ASD-B2-0121- B | ASD-B2-0221- B | ASD-B2-0421- B | ASD-B2-0721-B | ASD-B2-1021-B | ASD-B2-1521-B | ASD-B2-2023-B | ASD-B2-3023- B |

| | | | | | | | | | | | | | | | | |
|--------------------|---|---------------|---|---|--|---------------|---|--|--|--|---|--|---|--|---|--|
| Servo Motor |  | |  | |  | |  | |  | |  | |  | |  | |
| | ECMA-CΔ0401□S | ECMA-CΔ0602□S | ECMA-CΔ0604□S ECMA-CΔ0604□H ECMA-CΔ0804□7 ECMA-EΔ1305□S ECMA-GΔ1303□S | ECMA-CΔ0807□S ECMA-CΔ0807□H ECMA-GΔ1306□S ECMA-GM1306PS ECMA-CΔ0907□S | ECMA-CΔ1010□S ECMA-EΔ1310□S ECMA-GΔ1309□S ECMA-GM1309PS ECMA-CΔ0910□S ECMA-FΔ1308□S | ECMA-EΔ1315□S | ECMA-CΔ1020□S ECMA-FΔ1313□S ECMA-EΔ1320□S ECMA-EΔ1820□S ECMA-FΔ1318□S | ECMA-EΔ1830□S ECMA-FΔ1830□S ECMA-EΔ1835□S ECMA-CΔ1330□4 | | | | | | | | |

Note:
 1. (□) in the model names represent shaft end/brake or the number of oil seals.
 2. (Δ) in the model names represent encoder types (Δ =1: Incremental encoder, 20-bit; Δ =2: Incremental encoder, 17-bit).

Part Names and Functions

LED Display

- The 5-digit, 7-segment LED displays the servo status or fault codes.

Charge LED

- A lit LED indicates that either power is connected to the servo drive or a residual charge is present in the drive's internal power components.

Operation Panel

- Function keys used to perform status display, monitor and diagnostic, function and parameter setting.

Function Keys:

MODE: Mode selection

SHIFT: For shifting the cursor to the left

▲ : For increasing values

▼ : For decreasing values

SET: For storing data

Control Circuit Terminal (L1c, L2c)

- Used to connect 200~230 V_{AC}, 50/60Hz single-phase or three-phase V_{AC} supply.

Main Circuit Terminal (R, S, T)

- Used to connect 200~230 V_{AC}, 50/60Hz commercial power supply.

Servo Motor Output (U, V, W)

- Used to connect the servo motor. Never connect the output terminal to the main circuit power as the AC servo drive may be damaged beyond repair if incorrect cables are connected to the output terminals.

Regenerative Resistor

- When using an external resistor, connect it to P ⊕ and C, and ensure an open circuit between P ⊕ and D.
- When using an internal resistor, ensure the circuit is closed between P ⊕ and D, and the circuit is open between P ⊕ and C
- When using external braking unit, connect braking unit to P ⊕ and ⊖, and ensure an open circuit between P ⊕ and D, and P ⊕ and C.

Ground Terminal





I/O Interface

- Used to connect Delta's DVP Series PLC or other external controllers for controlling I/O signals.

Motor Encoder Interface

- Used to connect the encoder.

Serial Communication Port

- Used to connect PLC, HMI, and other controllers for RS-485/RS-232 serial communication.

Reserved

Analog Voltage Output Terminal

- Used to provide two analog monitor outputs, MON1 and MON2.

Heatsink

- Used to secure servo drive and for heat dissipation.



NOTE

Please note that this only introduces a servo drive's basic functions. Specific models may have different functions.

Wiring

Position (Pt) Control Mode (for Pulse Command Input)

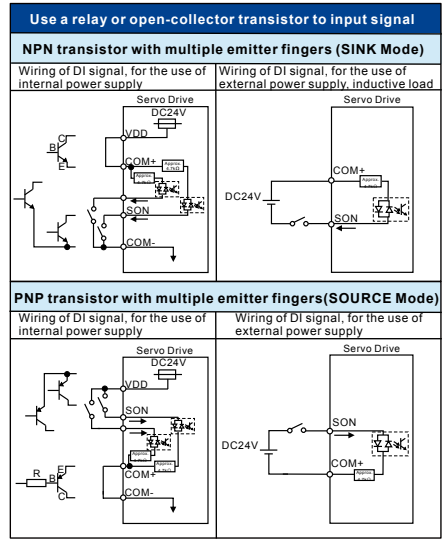
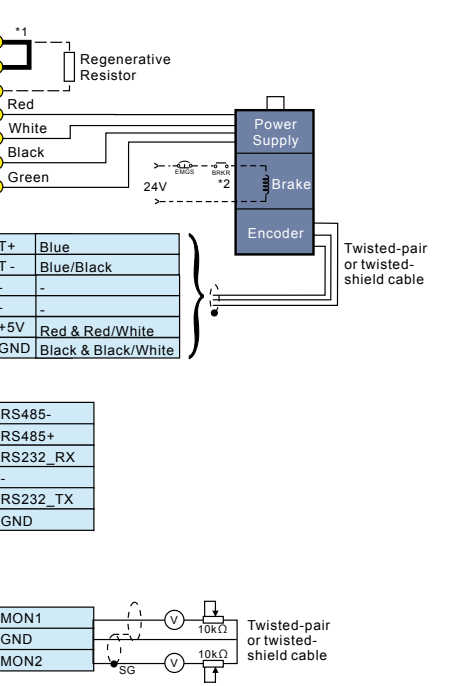
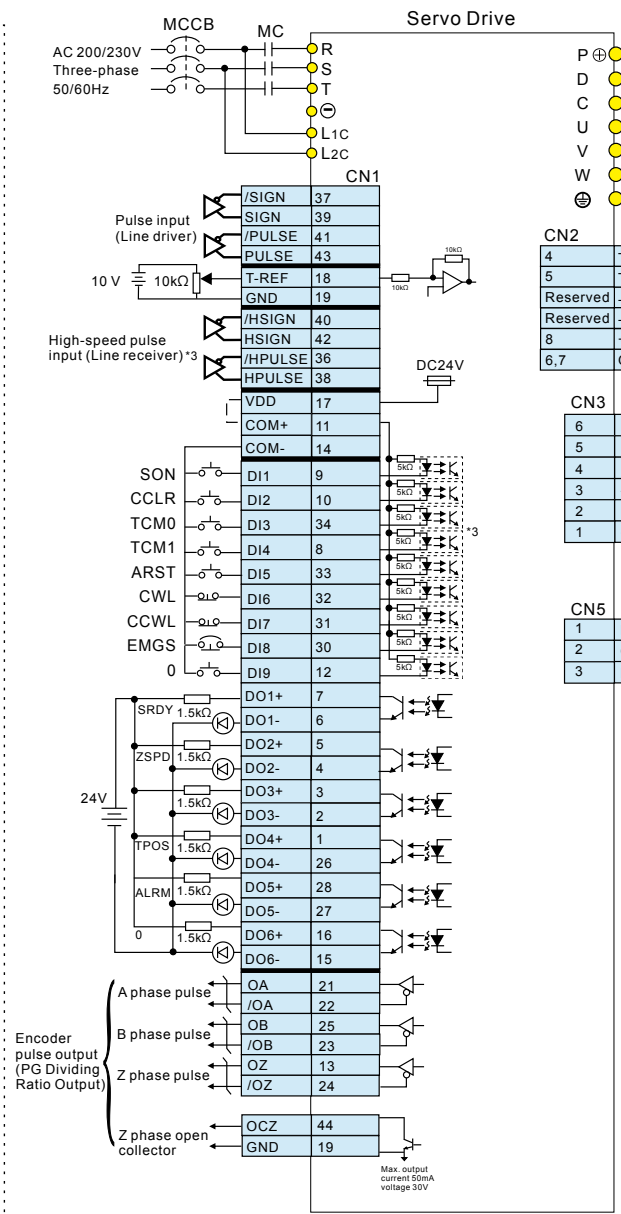
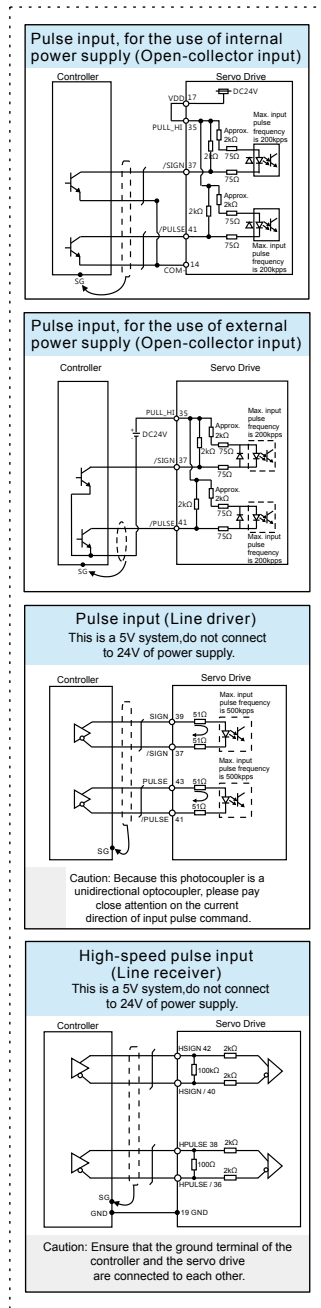

NOTE:
 *1. 200W and below drives do not provide built-in regenerative resistor.
 *2. The brake coil has no polarity.
 *3. Please refer to SINK / SOURCE modes

WARNING Caution: Do not use dual power supply. Failure to observe this caution may damage the servo drive.

Speed (S) Control Mode

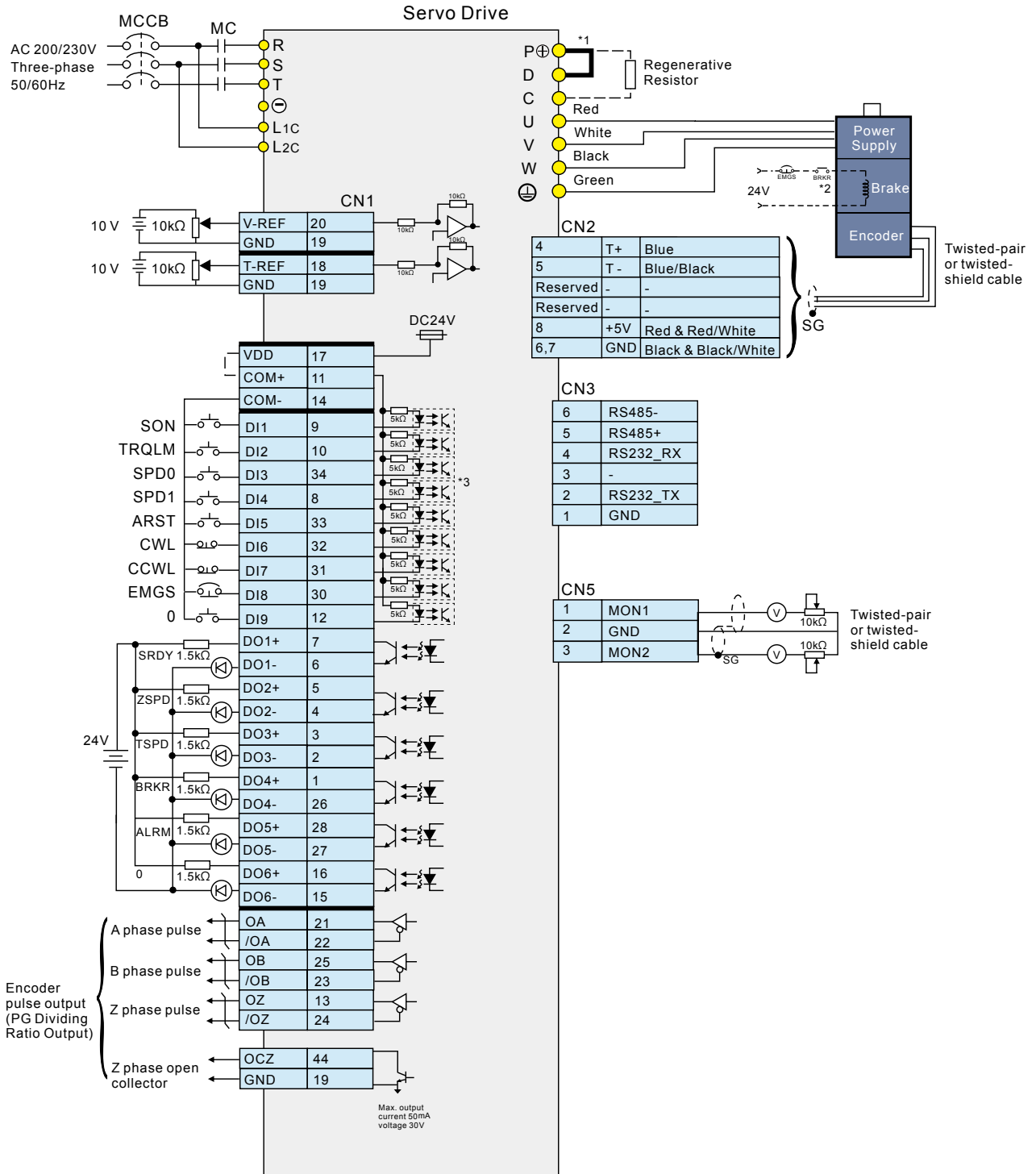

Wiring

Torque (T) Control Mode

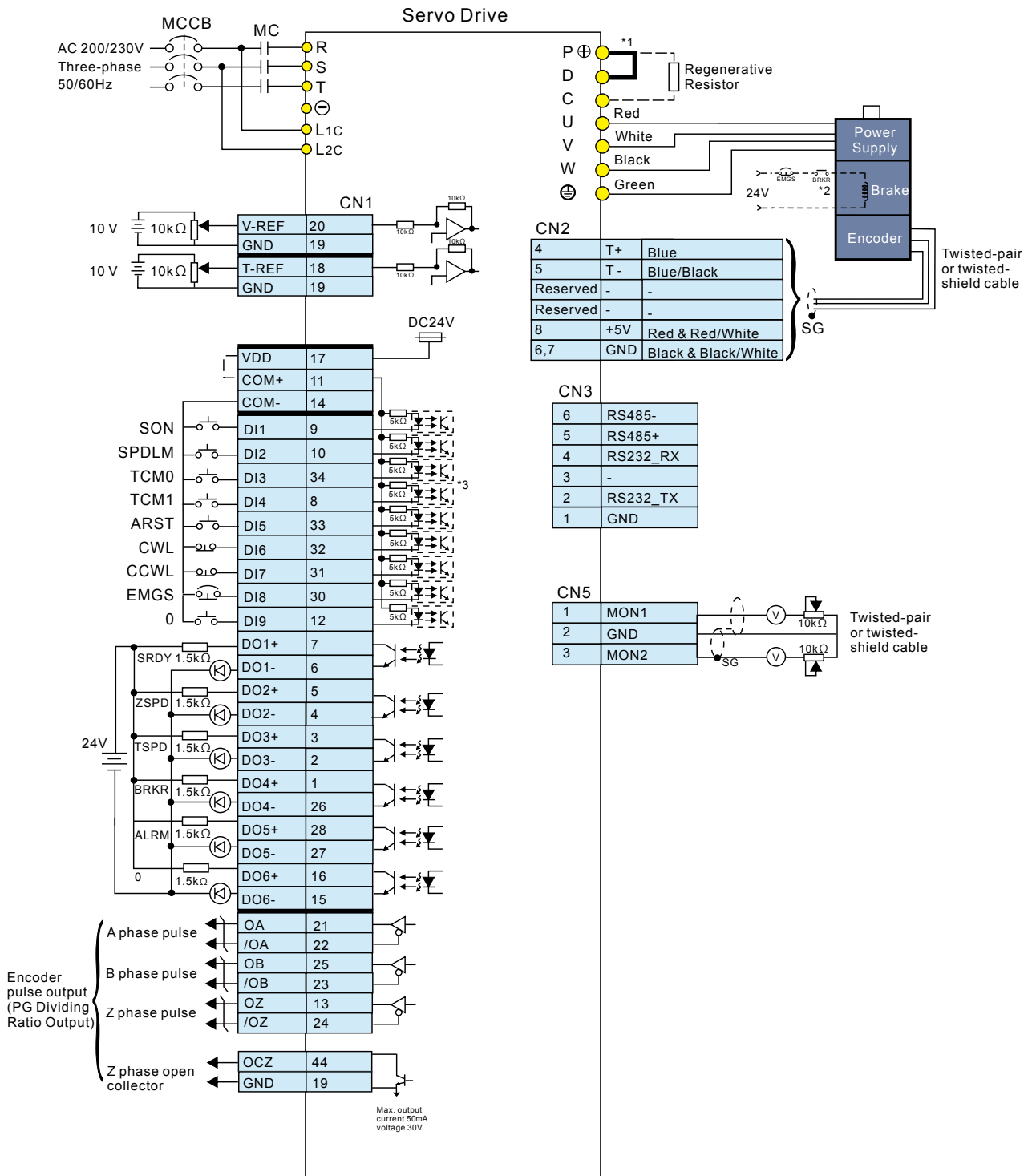

NOTE:
 *1. 200W and below drives do not provide built-in regenerative resistor.
 *2. The brake coil has no polarity.
 *3. Please refer to SINK / SOURCE modes

Selection of Regenerative Resistor

| Servo Drive (kW) | Recommended Specifications for Built-in Regenerative Resistor | | The capacity of built-in regenerative resistor (Watt) | Min. Allowable Resistance (Ohm) |
|------------------|---|-----------------------------------|---|---------------------------------|
| | Resistance (Ohm) (parameter P1-52) | Capacity (Watt) (parameter P1-53) | | |
| 0.1 | -- | -- | -- | 60Ω |
| 0.2 | -- | -- | -- | 60Ω |
| 0.4 | 100Ω | 60W | 30W | 60Ω |
| 0.75 | 100Ω | 60W | 30W | 60Ω |
| 1.0 | 40Ω | 60W | 30W | 30Ω |
| 1.5 | 40Ω | 60W | 30W | 30Ω |
| 2.0 | 20Ω | 100W | 50W | 15Ω |
| 3.0 | 20Ω | 100W | 50W | 15Ω |

Note:

- 1) 100W ~ 200W of B2 servo drives have no built-in regenerative resistor.
- 2) When the fault, ALE05 (Regeneration Error) occurs, please increase the regenerative resistor capacity or decrease the regenerative resistor resistance (the regenerative resistor resistance should not be less than the minimum allowable resistance listed in the above table.)
- 3) If the issue persists, please purchase a regenerative resistor module.
- 4) When connecting to a regenerative resistor in parallel, make sure that the total resistance value of the regenerative resistors is not less than the minimum allowable resistance listed in the above table.

Safety Information

| Global Standards | ASDA-B2 Series is designed to fully comply with demanding international standards, such as IEC and EN for all fields of industrial automation technology. |
|---|---|
| EMC Standard | EN61000-4-6 Level 3 |
| | EN61000-4-3 Level 3 |
| | EN61000-4-2 Level 2 and Level 3 |
| | EN61000-4-4 Level 3 |
| | EN61000-4-8 Level 4 |
| | EN61000-4-5 Level 3 |
| Conducted & Radiated Emissions | Complies with EN550011 Group 1, Class A, with external EMC filter |
| CE Marking | CE recognized. Complies with Directive 2006/95/EC of the European Parliament and EMC Directive 2004/108/EC. |
| Protection Degree | IEC/EN50178, IEC/EN60529 IP20 |
| Vibration | 1G less than 20 Hz, 0.6G 20 to 50 Hz. Complies with IEC/EN50178 |
| Shock | 15gn 11 ms. Complies with IEC/EN600028-2-27 |
| Pollution Degree | Degree 2. Complies with IEC/EN61800-5-1 |
| Ambient Temperature | Operating: 0°C ~ 55°C (If operating temperature exceeds the specifications, forced cooling will be required.) Storage: -20°C ~ 65°C |
| Cooling Type | ASD-B2-0121-B, ASD-B2-0221-B, ASD-B2-0421-B, ASD-B2-0721-B Natural Air Circulation |
| | ASD-B2-1021-B, ASD-B2-1521-B, ASD-B2-2023-B, ASD-B2-3023-B Fan Cooling |
| Altitude | Altitude 1000m or lower above sea level |





IEC: International Electrotechnical Commission
 EN: Europäischen Normen
 EMC: Electromagnetic Compatibility
 IP: Ingress Protection Ratings



Specifications

| ASDA-B2 Series | | 100 W | 200 W | 400 W | 750 W | 1 kW | 1.5 kW | 2 kW | 3 kW | |
|------------------------------|---|--|-------------------------|-------|----------|-------------|--------|--|------|--|
| | | 01 | 02 | 04 | 07 | 10 | 15 | 20 | 30 | |
| Power Supply | Phase / Voltage | Three-phase 170 ~ 255 V _{AC} , 50/60 Hz ±5% | | | | | | Three - phase 170 ~ 255 V _{AC} , 50/60 Hz ±5% | | |
| | Input Current (3PH) (Units: Arms) | 0.7 | 1.11 | 1.86 | 3.66 | 4.68 | 5.9 | 8.76 | 9.83 | |
| | Input Current (1PH) (Units: Arms) | 0.9 | 1.92 | 3.22 | 6.78 | 8.88 | 10.3 | - | - | |
| | Continuous Output Current (Units: Arms) | 0.9 | 1.55 | 2.6 | 5.1 | 7.3 | 8.3 | 13.4 | 19.4 | |
| Cooling System | | Natural Air Circulation | | | | Fan Cooling | | | | |
| Encoder Resolution | | 17-bit (160,000 p/rev) | | | | | | | | |
| Main Circuit Control | | SVPWM (Space Vector Pulse Width Modulation) Control | | | | | | | | |
| Control Mode | | Auto / Manual | | | | | | | | |
| Regenerative Resistor | | None | | | Built-in | | | | | |
| Position Control Mode | Max. Input Pulse Frequency | Transmitted by differential: 500K (low speed) / 4 Mpps (high-speed) Transmitted by open-collector: 200Kpps | | | | | | | | |
| | Pulse Type | Pulse + Direction, A phase + B phase, CCW pulse + CW pulse | | | | | | | | |
| | Command Source | External pulse | | | | | | | | |
| | Smoothing Strategy | Low-pass filter | | | | | | | | |
| | E-gear Ratio | Electronic gear N/M multiple N: 1 ~ (2 ²⁶ -1) / M: 1 ~ (2 ³¹ -1) (1/50 < N/M < 25600) | | | | | | | | |
| | Torque Limit Operation | Set by parameters | | | | | | | | |
| | Feed Forward Compensation | Set by parameters | | | | | | | | |
| Speed Control Mode | Analog Input Command | Voltage Range | 0 ~ ±10 V _{DC} | | | | | | | |
| | | Input Resistance | 10KΩ | | | | | | | |
| | | Time Constant | 2.2 μs | | | | | | | |
| | Speed Control Range ^{*1} | 1:5000 | | | | | | | | |
| | Command Source | External analog signal / Internal parameters | | | | | | | | |
| | Smoothing Strategy | Low-pass and S-curve filter | | | | | | | | |
| | Torque Limit | Set by parameters or via analog input | | | | | | | | |
| | Bandwidth | Maximum 550 Hz | | | | | | | | |
| Speed Accuracy ^{*2} | ±0.01% at 0 to 100% load fluctuation | | | | | | | | | |
| | ±0.01% at ±10% power fluctuation | | | | | | | | | |
| | ±0.01% at 0 °C to 50 °C ambient temperature fluctuation | | | | | | | | | |

Specifications

| ASDA-B2 Series | | 100 W | 200 W | 400 W | 750 W | 1 kW | 1.5 kW | 2 kW | 3 kW |
|-------------------------|-----------------------|---|-------------------------|-------|-------|------|--------|------|------|
| | | 01 | 02 | 04 | 07 | 10 | 15 | 20 | 30 |
| Torque Control Mode | Analog Input Command | Voltage Range | 0 ~ ±10 V _{DC} | | | | | | |
| | | Input Resistance | 10 KΩ | | | | | | |
| | | Time Constant | 2.2 μs | | | | | | |
| | Command Source | External analog signal / Internal parameters | | | | | | | |
| | Smoothing Strategy | Low-pass filter | | | | | | | |
| | Speed Limit | Set by parameters or via analog input | | | | | | | |
| Analog Monitor Output | | Monitor signal can set by parameters (Output voltage range: ±8 V) | | | | | | | |
| Digital Input / Output | Input | Servo on, Fault reset, Gain switch, Pulse clear, Zero clamp, Command input reverse control, Torque limit, Speed limit, Speed command selection, Speed/position mode switching, Speed/torque mode switching, Torque/position mode switching, Emergency stop, Positive/negative limit, Forward/reverse operation torque limit, Forward/reverse JOG input, E-gear N selection, Pulse input prohibition | | | | | | | |
| | Output | Encoder signal output (A, B, Z Line Driver / Z Open collector) Servo on, Servo ready, Zero speed, Target speed reached, Target position reached, Torque limiting, Servo alarm, Brake control, Early warning for overload, Servo warning | | | | | | | |
| Protective Functions | | Over current, Overvoltage, Under voltage, Overheat, Excessive speed deviation, Excessive position deviation, Encoder error, Emergency stop, Communication error, Short-circuit protection of terminal U, V, W and CN1, CN2, CN3 | | | | | | | |
| Communication Interface | | RS-232 / RS-485 | | | | | | | |
| Environment | Installation Site | Indoor location (avoid direct sunlight), no corrosive liquid and gas (avoid oil mist, flammable gas, dust) | | | | | | | |
| | Altitude | Altitude 1000 m or lower above sea level | | | | | | | |
| | Atmospheric Pressure | 86 kPa ~ 106 kPa | | | | | | | |
| | Operating Temperature | 0°C ~ 55°C (If operating temperature is above 45°C, forced cooling will be required) | | | | | | | |
| | Storage Temperature | -20°C ~ 65°C (-4°F to 149°F) | | | | | | | |
| | Humidity | 0 to 90% (non-condensing) | | | | | | | |
| | Vibration | Under 20 Hz, 9.80665 m/s ² (1G), 20 ~ 50 Hz 5.88 m/s ² (0.6 G) | | | | | | | |
| | IP Rating | IP20 | | | | | | | |
| | Power System | TN System ³ | | | | | | | |
| | Certifications | IEC/EN 61800-5-1     | | | | | | | |

Footnote:

*1. When it is in rated load, the speed ratio is: the minimum speed (smooth operation) / rated speed.

*2. When the command is the rated speed, the velocity correction ratio is: (rotational speed with no load - rotational speed with full load) / rated speed.

*3. TN system: The neutral point of the power system connects to the ground directly. The exposed metal components connect to the ground via the protective earth conductor.



Dimensions

ASD-B2-0121
ASD-B2-0221
ASD-B2-0421
(100 W / 200 W / 400 W)

Weight
 1.07 (2.36)

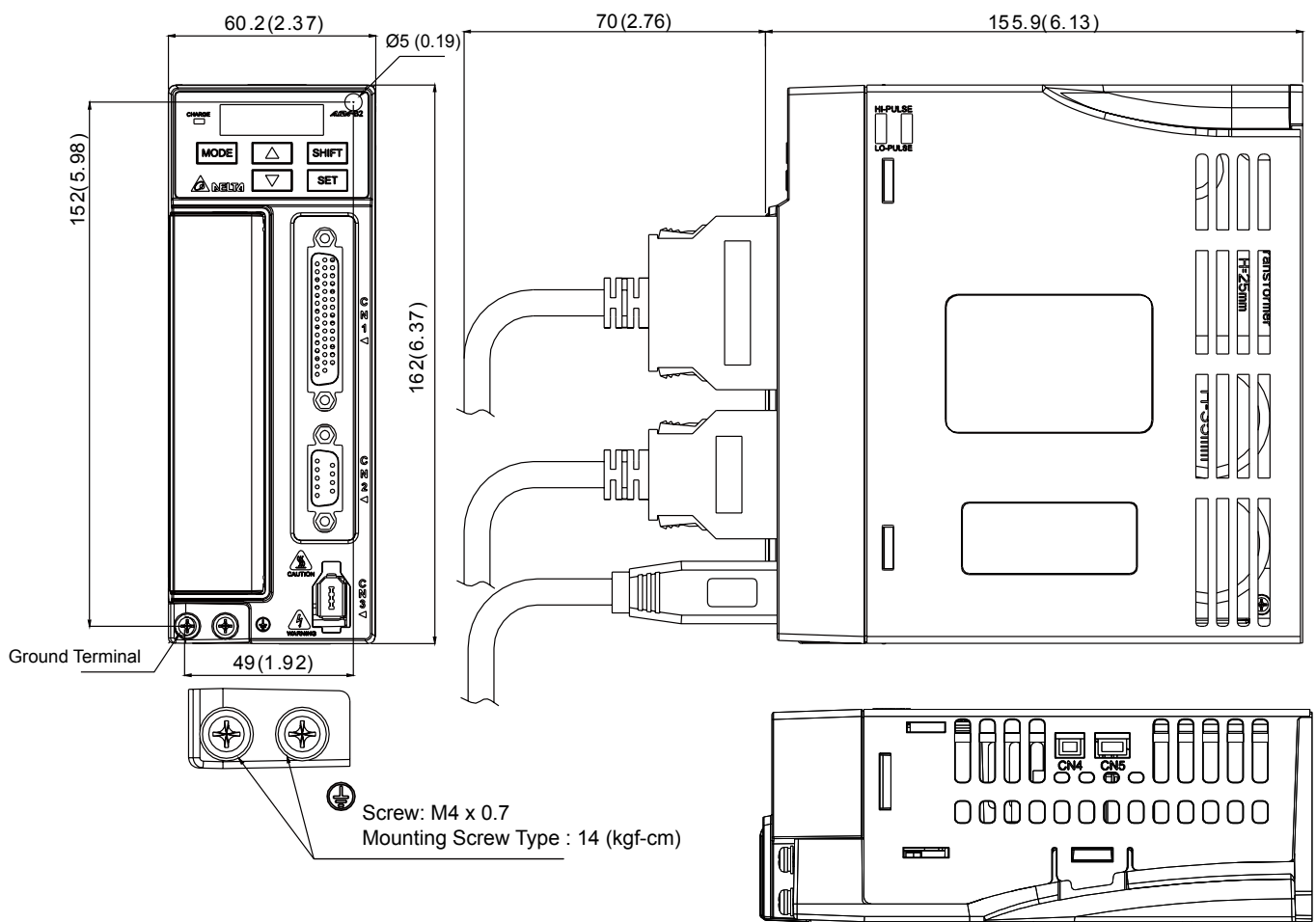

NOTE

- 1) Dimensions are in millimeters (inches); Weights are in kilograms (kg) and pounds (lbs).
- 2) Dimensions and weights of the servo drive may be updated without prior notice.

ASD-B2-0721 (750W)

Weight
1.54 (3.40)

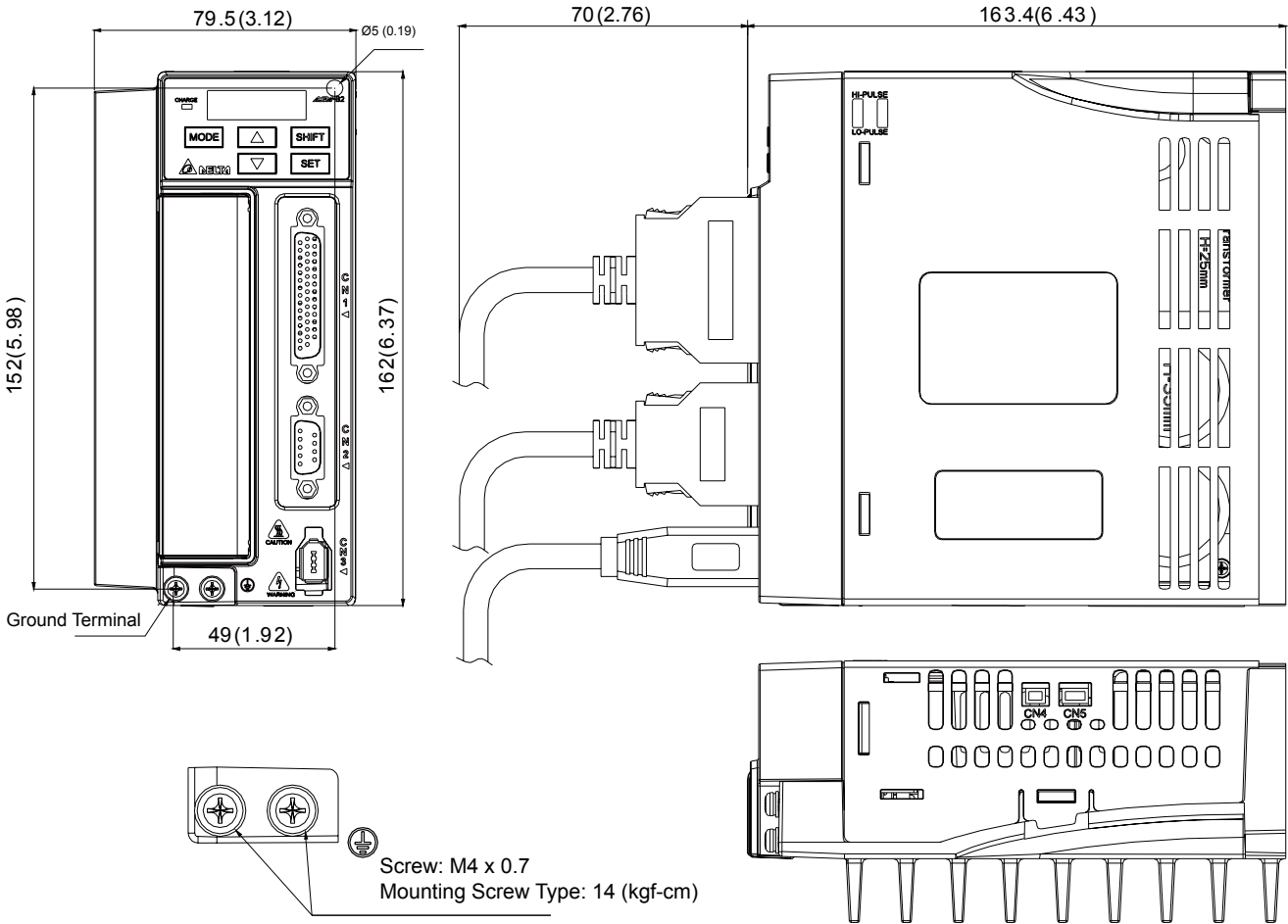

NOTE

- 1) Dimensions are in millimeters (inches); Weights are in kilograms (kg) and pounds (lbs).
- 2) Dimensions and weights of the servo drive may be updated without prior notice.

Dimensions

ASD-B2-1021
ASD-B2-1521
(1kW / 1.5kW)

Weight

1.72 (3.79)

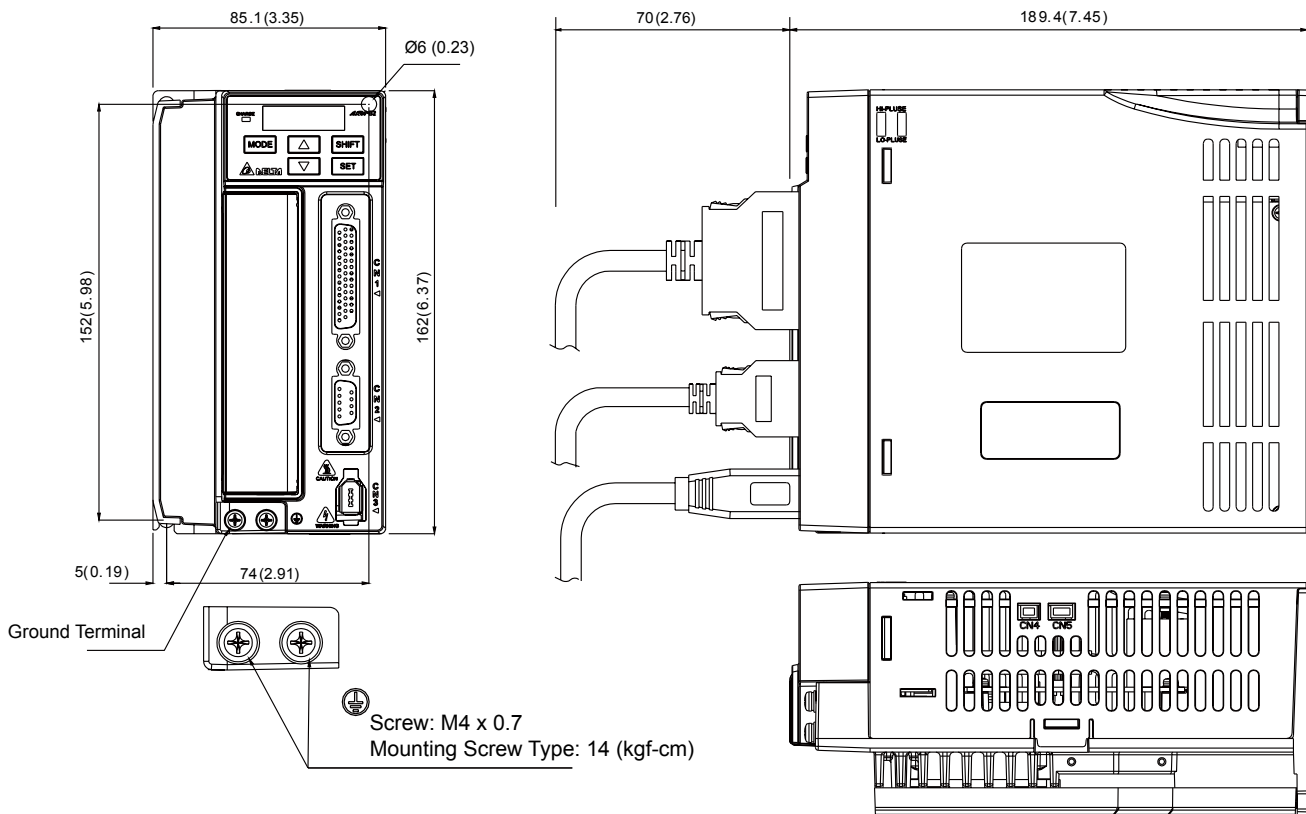

NOTE

- 1) Dimensions are in millimeters (inches); Weights are in kilograms (kg) and pounds (lbs).
- 2) Dimensions and weights of the servo drive may be updated without prior notice.

**ASD-B2-2023
ASD-B2-3023
(2kW / 3kW)**

| Weight |
|-------------|
| 2.67 (5.88) |

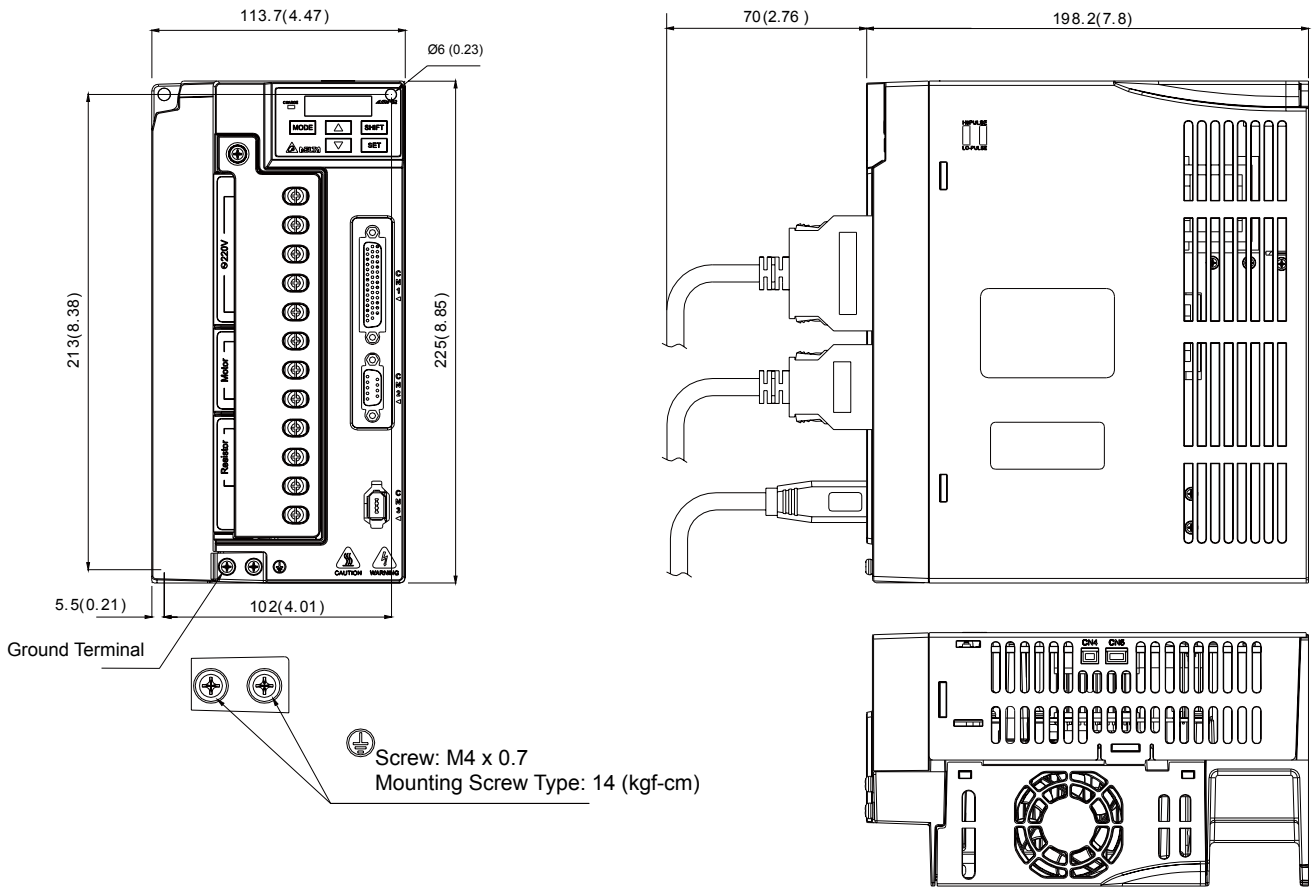

NOTE

- 1) Dimensions are in millimeters (inches); Weights are in kilograms (kg) and pounds (lbs).
- 2) Dimensions and weights of the servo drive may be updated without prior notice.

Servo Motor Specifications

Low Inertia Series

| Model: ECMA Series | C△04 | | | C△06 | | | C△08 | | | C△09 | | C△10 | | C△13 |
|---|--|-------|-------|------|------|------|-------|------|-------|--------|------|------|--|------|
| | 01 | 02 | 04□S | 04 | 07 | 07 | 10 | 10 | 20 | 30 | | | | |
| Rated power (kW) | 0.1 | 0.2 | 0.4 | 0.4 | 0.75 | 0.75 | 1.0 | 1.0 | 2.0 | 3.0 | | | | |
| Rated torque (N-m) ¹ | 0.32 | 0.64 | 1.27 | 1.27 | 2.39 | 2.39 | 3.18 | 3.18 | 6.37 | 9.55 | | | | |
| Maximum torque (N-m) | 0.96 | 1.92 | 3.82 | 3.82 | 7.16 | 7.14 | 8.78 | 9.54 | 19.11 | 28.65 | | | | |
| Rated speed (r/min) | 3000 | | | 3000 | | | 3000 | | 3000 | | 3000 | | | |
| Maximum speed (r/min) | 5000 | | | 3000 | | | 5000 | | 4500 | | | | | |
| Rated current (A) | 0.90 | 1.55 | 2.6 | 2.6 | 5.1 | 3.66 | 4.25 | 7.3 | 12.05 | 17.2 | | | | |
| Maximum current (A) | 2.70 | 4.65 | 7.8 | 7.8 | 15.3 | 11 | 12.37 | 21.9 | 36.15 | 47.5 | | | | |
| Power rating (kW/s) | 27.7 | 22.4 | 57.6 | 24.0 | 50.4 | 29.6 | 38.6 | 38.1 | 90.6 | 71.8 | | | | |
| Rotor inertia (x10 ⁻⁴ kg-m ²)(without brake) | 0.037 | 0.177 | 0.277 | 0.68 | 1.13 | 1.93 | 2.62 | 2.65 | 4.45 | 12.7 | | | | |
| Mechanical constant (ms) | 0.75 | 0.80 | 0.53 | 0.74 | 0.63 | 1.72 | 1.20 | 0.74 | 0.61 | 1.11 | | | | |
| Torque constant-KT (N-m/A) | 0.36 | 0.41 | 0.49 | 0.49 | 0.47 | 0.65 | 0.75 | 0.44 | 0.53 | 0.557 | | | | |
| Voltage constant-KE(mV/(r/min)) | 13.6 | 16 | 17.4 | 18.5 | 17.2 | 24.2 | 27.5 | 16.8 | 19.2 | 20.98 | | | | |
| Armature resistance (Ohm) | 9.30 | 2.79 | 1.55 | 0.93 | 0.42 | 1.34 | 0.897 | 0.20 | 0.13 | 0.0976 | | | | |
| Armature inductance (mH) | 24.0 | 12.07 | 6.71 | 7.39 | 3.53 | 7.55 | 5.7 | 1.81 | 1.50 | 1.21 | | | | |
| Electric constant (ms) | 2.58 | 4.3 | 4.3 | 7.96 | 8.36 | 5.66 | 6.35 | 9.3 | 11.4 | 12.4 | | | | |
| Insulation class | Class A (UL), Class B (CE) | | | | | | | | | | | | | |
| Insulation resistance | >100MΩ, 500V _{DC} | | | | | | | | | | | | | |
| Insulation strength | 1.8kV _{AC} , 1sec | | | | | | | | | | | | | |
| Weight (kg) (without brake) | 0.5 | 1.2 | 1.6 | 2.1 | 3.0 | 2.9 | 3.8 | 4.3 | 6.2 | 7.8 | | | | |
| Weight (kg) (with brake) | 0.8 | 1.5 | 2.0 | 2.9 | 3.8 | 3.69 | 5.5 | 4.7 | 7.2 | 9.2 | | | | |
| Max. radial shaft load (N) | 78.4 | 196 | 196 | 245 | 245 | 245 | 245 | 490 | 490 | 490 | | | | |
| Max. thrust shaft load (N) | 39.2 | 68 | 68 | 98 | 98 | 98 | 98 | 98 | 98 | 98 | | | | |
| Power rating (kW/s) (with brake) | 25.6 | 21.3 | 53.8 | 22.1 | 48.4 | 29.3 | 37.9 | 30.4 | 82 | 65.1 | | | | |
| Rotor inertia (x10 ⁻⁴ kg-m ²) (with brake) | 0.04 | 0.192 | 0.30 | 0.73 | 1.18 | 1.95 | 2.67 | 3.33 | 4.95 | 14.0 | | | | |
| Mechanical constant (ms) (with brake) | 0.81 | 0.85 | 0.57 | 0.78 | 0.65 | 1.74 | 1.22 | 0.93 | 0.66 | 1.22 | | | | |
| Brake holding torque [N·m (min)] ² | 0.3 | 1.3 | 1.3 | 2.5 | 2.5 | 2.5 | 2.5 | 8 | 8 | 10.0 | | | | |
| Brake power consumption (at 20°C) [W] | 7.3 | 6.5 | 6.5 | 8.2 | 8.2 | 8.2 | 8.2 | 18.7 | 18.7 | 19.0 | | | | |
| Brake release time [ms (Max)] | 5 | 10 | 10 | 10 | 10 | 10 | 10 | 10 | 10 | 10 | | | | |
| Brake pull-in time [ms (Max)] | 25 | 70 | 70 | 70 | 70 | 70 | 70 | 70 | 70 | 70 | | | | |
| Vibration grade (μm) | 15 | | | | | | | | | | | | | |
| Operating temperature (°C) | 0°C to 40°C (32°F to 104°F) | | | | | | | | | | | | | |
| Storage temperature (°C) | -10°C to 80°C (-14°F to 176°F) | | | | | | | | | | | | | |
| Operating humidity | 20 to 90% RH (non-condensing) | | | | | | | | | | | | | |
| Storage humidity | 20 to 90% RH (non-condensing) | | | | | | | | | | | | | |
| Vibration capacity | 2.5 G | | | | | | | | | | | | | |
| IP Rating | IP65 (when waterproof connectors are used, or when an oil seal is used to be fitted to the rotating shaft (an oil seal model is used)) | | | | | | | | | | | | | |
| Certifications |  | | | | | | | | | | | | | |

Footnote:

* 1 Rate torque values are continuous permissible values at 0-40°C ambient temperature when attaching with the sizes of heatsinks listed below:

ECMA-__04 / 06 / 08 : 250mm × 250mm × 6mm

ECMA-__10 : 300mm × 300mm × 12mm

ECMA-__13 : 400mm × 400mm × 20mm

ECMA-__18 : 550mm × 550mm × 30mm

ECMA-__22 : 650mm × 650mm × 30mm

Material type : Aluminum F40, F60, F80, F100, F130, F180, F220

*2 The holding brake is used to hold the motor shaft, not for braking the rotation. Never use it for decelerating or stopping the machine.

Servo Motor Specifications

Medium / High Inertia Series

| Model: ECMA Series | E△13 | | | | E△18 | | | G△13 | | |
|--|--|-------|-------|-------|-------|-------|-------|-------|-------|-------|
| | 05 | 10 | 15 | 20 | 20 | 30 | 35 | 03 | 06 | 09 |
| Rated power (kW) | 0.5 | 1.0 | 1.5 | 2.0 | 2.0 | 3.0 | 3.5 | 0.3 | 0.6 | 0.9 |
| Rated torque (N-m) ^{*1} | 2.39 | 4.77 | 7.16 | 9.55 | 9.55 | 14.32 | 16.71 | 2.86 | 5.73 | 8.59 |
| Maximum torque (N-m) | 7.16 | 14.3 | 21.48 | 28.65 | 28.65 | 42.97 | 50.13 | 8.59 | 17.19 | 21.48 |
| Rated speed (r/min) | 2000 | | | | | | | 1000 | | |
| Maximum speed (r/min) | 3000 | | | | | | | 2000 | | |
| Rated current (A) | 2.9 | 5.6 | 8.3 | 11.01 | 11.22 | 16.1 | 19.2 | 2.5 | 4.8 | 7.5 |
| Maximum current (A) | 8.7 | 16.8 | 24.9 | 33.03 | 33.66 | 48.3 | 57.6 | 7.5 | 14.4 | 22.5 |
| Power rating (kW/s) | 7.0 | 27.1 | 45.9 | 62.5 | 26.3 | 37.3 | 50.8 | 10.0 | 39.0 | 66.0 |
| Rotor inertia (x10-4kg-m ²)(without brake) | 8.17 | 8.41 | 11.18 | 14.59 | 34.68 | 54.95 | 54.95 | 8.17 | 8.41 | 11.18 |
| Mechanical constant (ms) | 1.91 | 1.51 | 1.10 | 0.96 | 1.62 | 1.06 | 1.08 | 1.84 | 1.40 | 1.06 |
| Torque constant-KT (N-m/A) | 0.83 | 0.85 | 0.87 | 0.87 | 0.85 | 0.89 | 0.87 | 1.15 | 1.19 | 1.15 |
| Voltage constant-KE(mV/(r/min)) | 30.9 | 31.9 | 31.8 | 31.8 | 31.4 | 32.0 | 32 | 42.5 | 43.8 | 41.6 |
| Armature resistance (Ohm) | 0.57 | 0.47 | 0.26 | 0.174 | 0.119 | 0.052 | 0.052 | 1.06 | 0.82 | 0.43 |
| Armature inductance (mH) | 7.39 | 5.99 | 4.01 | 2.76 | 2.84 | 1.38 | 1.38 | 14.29 | 11.12 | 6.97 |
| Electric constant (ms) | 12.96 | 12.88 | 15.31 | 15.86 | 23.87 | 26.39 | 26.39 | 13.55 | 13.50 | 16.06 |
| Insulation class | Class A (UL), Class B (CE) | | | | | | | | | |
| Insulation resistance | >100MΩ, 500V _{DC} | | | | | | | | | |
| Insulation strength | 1.8kV _{AC} , 1sec | | | | | | | | | |
| Weight (kg) (without brake) | 6.8 | 7.0 | 7.5 | 7.8 | 13.5 | 18.5 | 18.5 | 6.8 | 7.0 | 7.5 |
| Weight (kg) (with brake) | 8.2 | 8.4 | 8.9 | 9.2 | 17.5 | 22.5 | 22.5 | 8.2 | 8.4 | 8.9 |
| Max. radial shaft load (N) | 490 | 490 | 490 | 490 | 1176 | 1470 | 490 | 490 | 490 | 490 |
| Max. thrust shaft load (N) | 98 | 98 | 98 | 98 | 490 | 490 | 98 | 98 | 98 | 98 |
| Power rating (kW/s) (with brake) | 6.4 | 24.9 | 43.1 | 57.4 | 24.1 | 35.9 | 48.9 | 9.2 | 35.9 | 62.1 |
| Rotor inertia (x10-4kg-m ²) (with brake) | 8.94 | 9.14 | 11.90 | 15.88 | 37.86 | 57.06 | 57.06 | 8.94 | 9.14 | 11.9 |
| Mechanical constant (ms) (with brake) | 2.07 | 1.64 | 1.19 | 1.05 | 1.77 | 1.10 | 1.12 | 2.0 | 1.51 | 1.13 |
| Brake holding torque [Nt-m (min)] ^{*2} | 10.0 | 10.0 | 10.0 | 10.0 | 25.0 | 25.0 | 25.0 | 10.0 | 10.0 | 10.0 |
| Brake power consumption (at 20°C) [W] | 19.0 | 19.0 | 19.0 | 19.0 | 20.4 | 20.4 | 20.4 | 19.0 | 19.0 | 19.0 |
| Brake release time [ms (Max)] | 10 | 10 | 10 | 10 | 10 | 10 | 10 | 10 | 10 | 10 |
| Brake pull-in time [ms (Max)] | 70 | 70 | 70 | 70 | 70 | 70 | 70 | 70 | 70 | 70 |
| Vibration grade (μm) | 15 | | | | | | | | | |
| Operating temperature (°C) | 0°C to 40°C (32°F to 104°F) | | | | | | | | | |
| Storage temperature (°C) | -10°C to 80°C (-14°F to 176°F) | | | | | | | | | |
| Operating humidity | 20 to 90% RH (non-condensing) | | | | | | | | | |
| Storage humidity | 20 to 90% RH (non-condensing) | | | | | | | | | |
| Vibration capacity | 2.5G | | | | | | | | | |
| IP Rating | IP65 (when waterproof connectors are used, or when an oil seal is used to be fitted to the rotating shaft (an oil seal model is used)) | | | | | | | | | |
| Certifications |  | | | | | | | | | |

Footnote:

*1 Rate torque values are continuous permissible values at 0-40°C ambient temperature when attaching with the sizes of heatsinks listed below:

ECMA-__04 / 06 / 08 : 250mm x 250mm x 6mm

ECMA-__10 : 300mm x 300mm x 12mm

ECMA-__13 : 400mm x 400mm x 20mm

ECMA-__18 : 550mm x 550mm x 30mm

ECMA-__22 : 650mm x 650mm x 30mm

Material type : Aluminum F40, F60, F80, F100, F130, F180, F220

*2 The holding brake is used to hold the motor shaft, not for braking the rotation. Never use it for decelerating or stopping the machine.

Servo Motor Specifications

Medium high / High Inertia Series

| Model: ECMA Series | FΔ13 | | | FΔ18 |
|---|--|-------|-------|-------|
| | 08 | 13 | 18 | 30 |
| Rated power (kW) | 0.85 | 1.3 | 1.8 | 3.0 |
| Rated torque (N-m) ^{*1} | 5.41 | 8.34 | 11.48 | 19.10 |
| Maximum torque (N-m) | 13.8 | 23.3 | 28.7 | 57.29 |
| Rated speed (r/min) | 1500 | | | |
| Maximum speed (r/min) | 3000 | | | |
| Rated current (A) | 7.1 | 12.6 | 13 | 19.4 |
| Maximum current (A) | 19.4 | 38.6 | 36 | 58.2 |
| Power rating (kW/s) | 21.52 | 34.78 | 52.93 | 66.4 |
| Rotor inertia (x10 ⁻⁴ kg-m ²)(without brake) | 13.6 | 20 | 24.9 | 54.95 |
| Mechanical constant (ms) | 2.43 | 1.62 | 1.7 | 1.28 |
| Torque constant-KT (N-m/A) | 0.76 | 0.66 | 0.88 | 0.98 |
| Voltage constant-KE(mV/(r/min)) | 29.2 | 24.2 | 32.2 | 35.0 |
| Armature resistance (Ohm) | 0.38 | 0.124 | 0.185 | 0.077 |
| Armature inductance (mH) | 4.77 | 1.7 | 2.6 | 1.27 |
| Electric constant (ms) | 12.55 | 13.71 | 14.05 | 16.5 |
| Insulation class | Class A (UL), Class B (CE) | | | |
| Insulation resistance | >100MΩ, 500 V _{DC} | | | |
| Insulation strength | 1.8kV _{AC} , 1 sec | | | |
| Weight (kg) (without brake) | 8.6 | 9.4 | 10.5 | 18.5 |
| Weight (kg) (with brake) | 10.0 | 10.8 | 11.9 | 22.5 |
| Max. radial shaft load (N) | 490 | 490 | 490 | 1470 |
| Max. thrust shaft load (N) | 98 | 98 | 98 | 490 |
| Power rating (kW/s) (with brake) | 19.78 | 32.66 | 50.3 | 63.9 |
| Rotor inertia (x10 ⁻⁴ kg-m ²) (with brake) | 14.8 | 21.3 | 26.2 | 57.06 |
| Mechanical constant (ms) (with brake) | 2.65 | 1.73 | 1.79 | 1.33 |
| Brake holding torque [Nt-m (min)] ^{*2} | 10.0 | 10.0 | 10.0 | 25.0 |
| Brake power consumption (at 20°C) [W] | 19.0 | 19.0 | 19.0 | 20.4 |
| Brake release time [ms (Max)] | 10 | 10 | 10 | 10 |
| Brake pull-in time [ms (Max)] | 70 | 70 | 70 | 70 |
| Vibration grade (μm) | 15 | | | |
| Operating temperature (°C) | 0°C~ 40°C | | | |
| Storage temperature (°C) | -10°C to 80°C (-14°F to 176°F) | | | |
| Operating humidity | 20 to 90% RH (non-condensing) | | | |
| Storage humidity | 20 to 90% RH (non-condensing) | | | |
| Vibration capacity | 2.5G | | | |
| IP Rating | IP65 (when waterproof connectors are used, or when an oil seal is used to be fitted to the rotating shaft (an oil seal model is used)) | | | |
| Certifications |  | | | |

Footnote:

*1 Rate torque values are continuous permissible values at 0 ~ 40° C ambient temperature when attaching with the sizes of heatsinks listed below:

ECMA-__04 / 06 / 08 : 250mm x 250mm x 6mm

ECMA-__10 : 300mm x 300mm x 12mm

ECMA-__13 : 400mm x 400mm x 20mm

ECMA-__18 : 550mm x 550mm x 30mm

ECMA-__22 : 650mm x 650mm x 35mm

Material type : Aluminum – F40, F60, F80, F100, F130, F180

*2 The holding brake is used to hold the motor shaft, not for braking the rotation. Never use it for decelerating or stopping the machine.

Servo Motor Specifications

High Inertia Series

| Model: ECMA Series | CΔ06 | CΔ08 |
|---|--|--------|
| | 04 □ H | 07 □ H |
| Rated power (kW) | 0.4 | 0.75 |
| Rated torque (N-m) ¹ | 1.27 | 2.39 |
| Maximum torque (N-m) | 3.82 | 7.16 |
| Rated speed (r/min) | 3000 | |
| Maximum speed (r/min) | 5000 | |
| Rated current (A) | 2.6 | 5.1 |
| Maximum current (A) | 7.8 | 15.3 |
| Power rating (kW/s) | 21.7 | 19.63 |
| Rotor inertia (x10 ⁻⁴ kg·m ²)(without brake) | 0.743 | 2.91 |
| Mechanical constant (ms) | 1.42 | 1.6 |
| Torque constant-KT (N-m/A) | 0.49 | 0.47 |
| Voltage constant-KE(mV/(r/min)) | 17.4 | 17.2 |
| Armature resistance (Ohm) | 1.55 | 0.42 |
| Armature inductance (mH) | 6.71 | 3.53 |
| Electric constant (ms) | 4.3 | 8.36 |
| Insulation class | Class A (UL), Class B (CE) | |
| Insulation resistance | >100MΩ, 500V _{DC} | |
| Insulation strength | 1.8kV _{AC} , 1 sec | |
| Weight (kg) (without brake) | 1.8 | 3.4 |
| Weight (kg) (with brake) | 2.2 | 3.9 |
| Max. radial shaft load (N) | 196 | 245 |
| Max. thrust shaft load (N) | 68 | 98 |
| Power rating (kW/s) (with brake) | 21.48 | 19.3 |
| Rotor inertia (x10 ⁻⁴ kg·m ²) (with brake) | 0.751 | 2.96 |
| Mechanical constant (ms) (with brake) | 1.43 | 1.62 |
| Brake holding torque [Nt·m (min)] ² | 1.3 | 2.5 |
| Brake power consumption (at 20 °C) [W] | 6.5 | 8.2 |
| Brake release time [ms (Max)] | 10 | 10 |
| Brake pull-in time [ms (Max)] | 70 | 70 |
| Vibration grade (μm) | 15 | |
| Operating temperature (°C) | 0°C~ 40°C | |
| Storage temperature (°C) | -10°C to 80°C (-14°F to 176°F) | |
| Operating humidity | 20 to 90% RH (non-condensing) | |
| Storage humidity | 20 to 90% RH (non-condensing) | |
| Vibration capacity | 2.5G | |
| IP Rating | IP65 (when waterproof connectors are used, or when an oil seal is used to be fitted to the rotating shaft (an oil seal model is used)) | |
| Certifications |  | |

Footnote:

*1 Rate torque values are continuous permissible values at 0 ~ 40° C ambient temperature when attaching with the sizes of heatsinks listed below:

- ECMA_04 / 06 / 08 : 250mm x 250mm x 6mm
- ECMA_10 : 300mm x 300mm x 12mm
- ECMA_13 : 400mm x 400mm x 20mm
- ECMA_18 : 550mm x 550mm x 30mm
- ECMA_22 : 650mm x 650mm x 35mm

Material type : Aluminum – F40, F60, F80, F100, F130, F180

*2 The holding brake is used to hold the motor shaft, not for braking the rotation. Never use it for decelerating or stopping the machine.

Servo Motor Dimensions

Motors - Frame Size 86mm and below

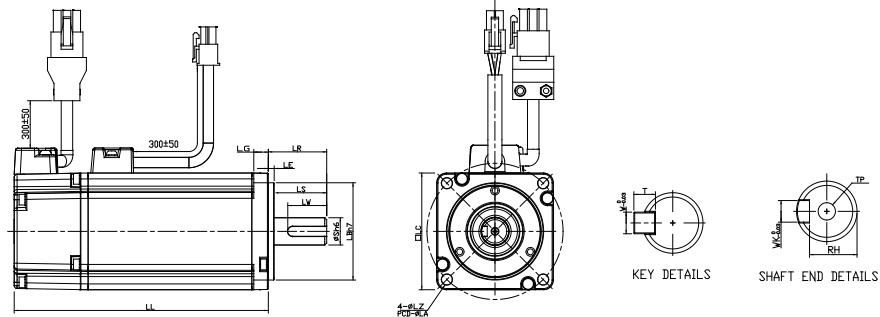

Units: mm

| Model | C Δ 0401 \square S | C Δ 0602 \square S | C Δ 0604 \square S | C Δ 0604 \square H | C Δ 0804 \square 7 | C Δ 0807 \square S | C Δ 0807 \square H | C Δ 0907 \square S | C Δ 0910 \square S |
|--------------------|-----------------------------|-----------------------------|-----------------------------|-----------------------------|-----------------------------|-----------------------------|-----------------------------|-----------------------------|-----------------------------|
| LC | 40 | 60 | 60 | 60 | 80 | 80 | 80 | 86 | 86 |
| LZ | 4.5 | 5.5 | 5.5 | 5.5 | 6.6 | 6.6 | 6.6 | 6.6 | 6.6 |
| LA | 46 | 70 | 70 | 70 | 90 | 90 | 90 | 100 | 100 |
| S | 8 (+0.009) | 14 (+0.011) | 14 (+0.011) | 14 (+0.011) | 14 (+0.011) | 19 (+0.013) | 19 (+0.013) | 16 (+0.011) | 16 (+0.011) |
| LB | 30 (+0.021) | 50 (+0.025) | 50 (+0.025) | 50 (+0.025) | 70 (+0.030) | 70 (+0.030) | 70 (+0.030) | 80 (+0.030) | 80 (+0.030) |
| LL (without brake) | 100.6 | 105.5 | 130.7 | 145.8 | 112.3 | 138.3 | 154.8 | 130.2 | 153.2 |
| LL (with brake) | 136.8 | 141.6 | 166.8 | 176.37 | 152.8 | 178 | 187.8 | 161.3 | 184.3 |
| LS | 20 | 27 | 27 | 27 | 27 | 32 | 32 | 30 | 30 |
| LR | 25 | 30 | 30 | 30 | 30 | 35 | 35 | 35 | 35 |
| LE | 2.5 | 3 | 3 | 3 | 3 | 3 | 3 | 3 | 3 |
| LG | 5 | 7.5 | 7.5 | 7.5 | 8 | 8 | 8 | 8 | 8 |
| LW | 16 | 20 | 20 | 20 | 20 | 25 | 25 | 20 | 20 |
| RH | 6.2 | 11 | 11 | 11 | 11 | 15.5 | 15.5 | 13 | 13 |
| WK | 3 | 5 | 5 | 5 | 5 | 6 | 6 | 5 | 5 |
| W | 3 | 5 | 5 | 5 | 5 | 6 | 6 | 5 | 5 |
| T | 3 | 5 | 5 | 5 | 5 | 6 | 6 | 5 | 5 |
| TP | M3 Depth 8 | M4 Depth 15 | M4 Depth 15 | M4 Depth 15 | M4 Depth 15 | M6 Depth 20 | M6 Depth 20 | M5 Depth 15 | M5 Depth 15 |



- 1) Dimensions are in millimeters. Actual measured values are in metric units.
- 2) Dimensions of the servo motor may be updated without prior notice.
- 3) The boxes (\square) in the model names represent shaft end/brake or the number of oil seal.
- 4) The boxes (Δ) in the model names represent encoder types (Δ =1: Incremental encoder, 20-bit; Δ =2: Incremental encoder, 17-bit).

Speed-Torque Curves (T-N Curves)

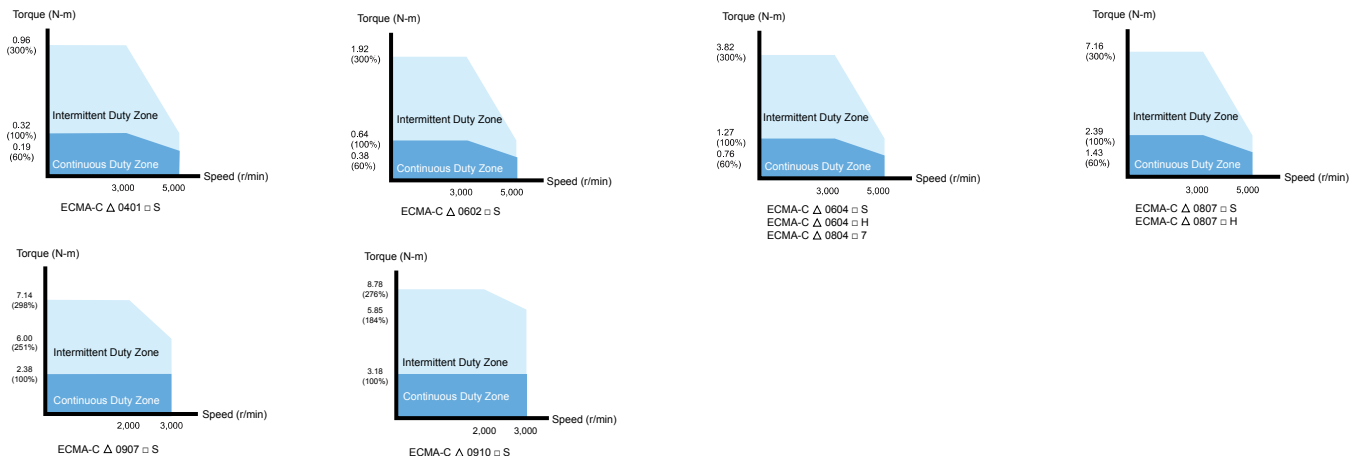

Motors - Frame Size 100mm ~ 130mm

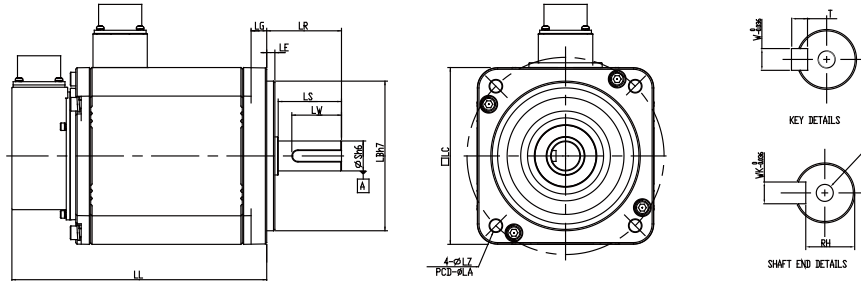

Units: mm

| Model | C Δ 1010 \square S | C Δ 1020 \square S | C Δ 1330 \square 4 | E Δ 1305 \square S | E Δ 1310 \square S | E Δ 1315 \square S |
|-----------|-----------------------------|-----------------------------|-----------------------------|-----------------------------|-----------------------------|-----------------------------|
| LC | 100 | 100 | 130 | 130 | 130 | 130 |
| LZ | 9 | 9 | 9 | 9 | 9 | 9 |
| LA | 115 | 115 | 145 | 145 | 145 | 145 |
| S | 22 ($^{+0}_{-0.013}$) | 22 ($^{+0}_{-0.013}$) | 24 ($^{+0}_{-0.013}$) | 22 ($^{+0}_{-0.013}$) | 22 ($^{+0}_{-0.013}$) | 22 ($^{+0}_{-0.013}$) |
| LB | 95 ($^{+0}_{-0.035}$) | 95 ($^{+0}_{-0.035}$) | 110 ($^{+0}_{-0.035}$) | 110 ($^{+0}_{-0.035}$) | 110 ($^{+0}_{-0.035}$) | 110 ($^{+0}_{-0.035}$) |
| LL (不帶煞車) | 153.3 | 199 | 187.5 | 147.5 | 147.5 | 167.5 |
| LL (帶煞車) | 192.5 | 226 | 216 | 183.5 | 183.5 | 202 |
| LS | 37 | 37 | 47 | 47 | 47 | 47 |
| LR | 45 | 45 | 55 | 55 | 55 | 55 |
| LE | 5 | 5 | 6 | 6 | 6 | 6 |
| LG | 12 | 12 | 11.5 | 11.5 | 11.5 | 11.5 |
| LW | 32 | 32 | 36 | 36 | 36 | 36 |
| RH | 18 | 18 | 20 | 18 | 18 | 18 |
| WK | 8 | 8 | 8 | 8 | 8 | 8 |
| W | 8 | 8 | 8 | 8 | 8 | 8 |
| T | 7 | 7 | 7 | 7 | 7 | 7 |
| TP | M6 Depth 20 | M6 Depth 20 | M6 Depth 20 | M6 Depth 20 | M6 Depth 20 | M6 Depth 20 |



- 1) Dimensions are in millimeters. Actual measured values are in metric units.
- 2) Dimensions of the servo motor may be updated without prior notice.
- 3) The boxes (\square) in the model names represent shaft end/brake or the number of oil seal.
- 4) The boxes (Δ) in the model names represent encoder types ($\Delta=1$: Incremental encoder, 20-bit; $\Delta=2$: Incremental encoder, 17-bit).

Speed-Torque Curves (T-N Curves)

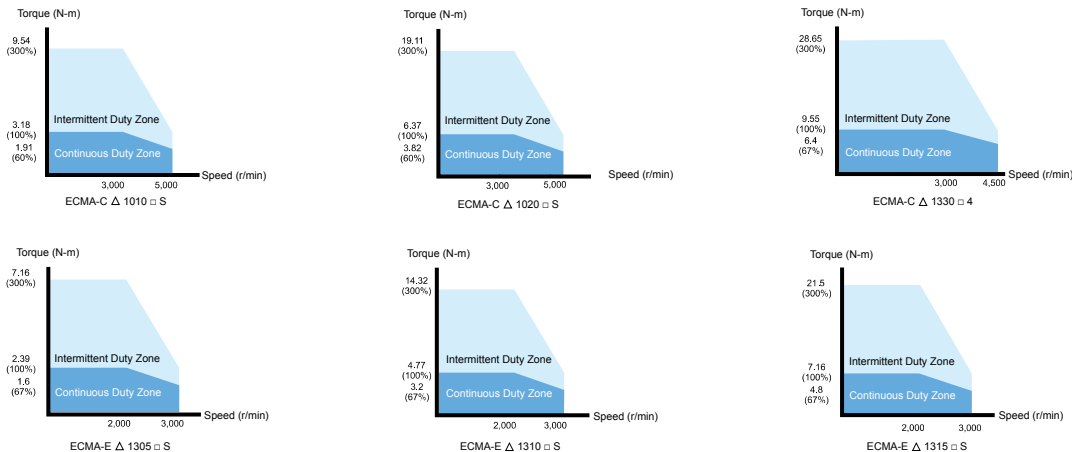

Servo Motor Dimensions

Motors - Frame Size 100mm ~ 130mm

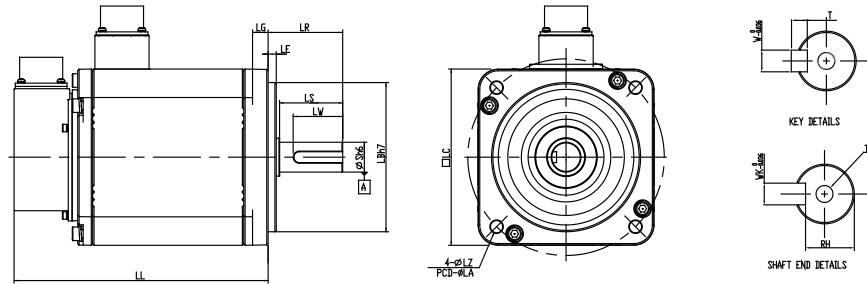

Units: mm

| Model | E Δ 1320 \square S | F Δ 1308 \square S | F Δ 1313 \square S | F Δ 1318 \square S | G Δ 1303 \square S | G Δ 1306 \square S | G Δ 1309 \square S |
|--------------------|-----------------------------|-----------------------------|-----------------------------|-----------------------------|-----------------------------|-----------------------------|-----------------------------|
| LC | 130 | 130 | 130 | 130 | 130 | 130 | 130 |
| LZ | 9 | 9 | 9 | 9 | 9 | 9 | 9 |
| LA | 145 | 145 | 145 | 145 | 145 | 145 | 145 |
| S | 22 (+0/-0.013) | 22 (+0/-0.013) | 22 (+0/-0.013) | 22 (+0/-0.013) | 22 (+0/-0.013) | 22 (+0/-0.013) | 22 (+0/-0.013) |
| LB | 110 (+0/-0.035) | 110 (+0/-0.035) | 110 (+0/-0.035) | 110 (+0/-0.035) | 110 (+0/-0.035) | 110 (+0/-0.035) | 110 (+0/-0.035) |
| LL (without brake) | 187.5 | 152.5 | 187.5 | 202 | 147.5 | 147.5 | 163.5 |
| LL (with brake) | 216 | 181 | 216 | 230.7 | 183.5 | 183.5 | 198 |
| LS | 47 | 47 | 47 | 47 | 47 | 47 | 47 |
| LR | 55 | 55 | 55 | 55 | 55 | 55 | 55 |
| LE | 6 | 6 | 6 | 6 | 6 | 6 | 6 |
| LG | 11.5 | 11.5 | 11.5 | 11.5 | 11.5 | 11.5 | 11.5 |
| LW | 36 | 36 | 36 | 36 | 36 | 36 | 36 |
| RH | 18 | 18 | 18 | 18 | 18 | 18 | 18 |
| WK | 8 | 8 | 8 | 8 | 8 | 8 | 8 |
| W | 8 | 8 | 8 | 8 | 8 | 8 | 8 |
| T | 7 | 7 | 7 | 7 | 7 | 7 | 7 |
| TP | M6 Depth 20 | M6 Depth 20 | M6 Depth 20 | M6 Depth 20 | M6 Depth 20 | M6 Depth 20 | M6 Depth 20 |



- 1) Dimensions are in millimeters. Actual measured values are in metric units.
- 2) Dimensions of the servo motor may be updated without prior notice.
- 3) The boxes (\square) in the model names represent shaft end/brake or the number of oil seal.
- 4) The boxes (Δ) in the model names represent encoder types (Δ =1: Incremental encoder, 20-bit; Δ =2: Incremental encoder, 17-bit).

Speed-Torque Curves (T-N Curves)

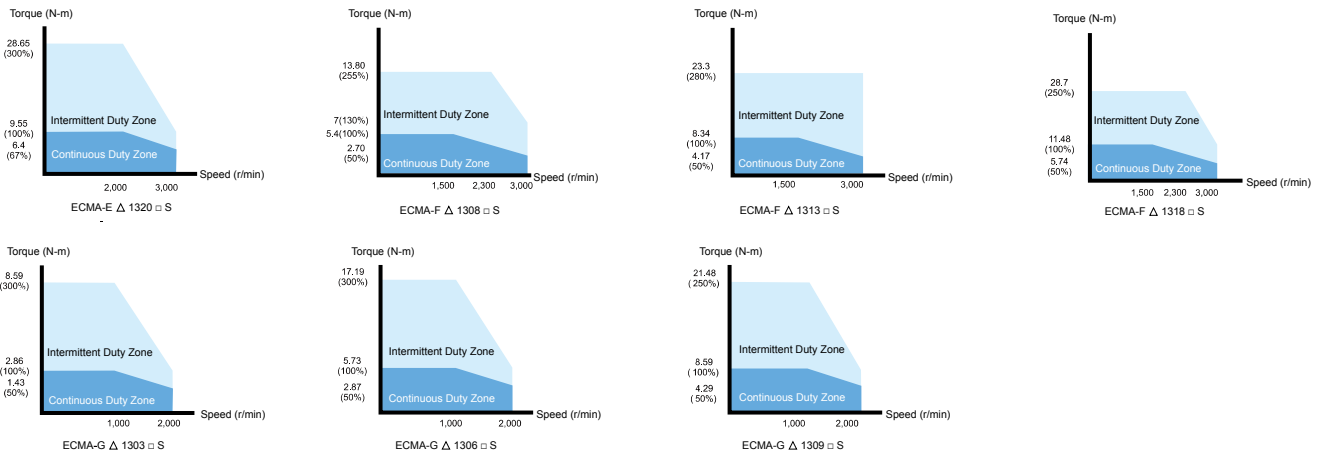

Motors - Frame Size 180mm

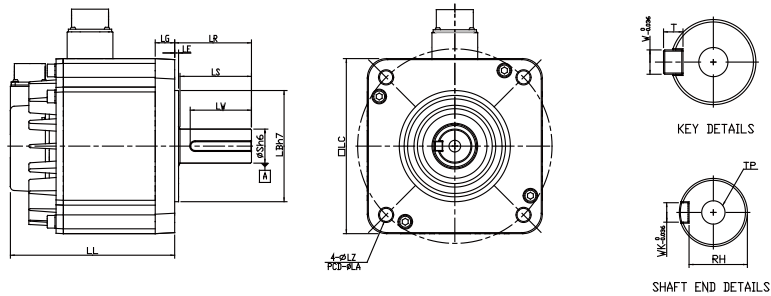

Units: mm

| Model | E Δ 1820 □ S | E Δ 1830 □ S | F Δ 1830 □ S | E Δ 1835 □ S |
|--------------------|---|---|---|---|
| LC | 180 | 180 | 180 | 180 |
| LZ | 13.5 | 13.5 | 13.5 | 13.5 |
| LA | 200 | 200 | 200 | 200 |
| S | 35 ⁺⁰ / _{-0.016} | 35 ⁺⁰ / _{-0.016} | 35 ⁺⁰ / _{-0.016} | 35 ⁺⁰ / _{-0.016} |
| LB | 114.3 ⁺⁰ / _{-0.035} | 114.3 ⁺⁰ / _{-0.035} | 114.3 ⁺⁰ / _{-0.035} | 114.3 ⁺⁰ / _{-0.035} |
| LL (without brake) | 169 | 202.1 | 202.1 | 202.1 |
| LL (with brake) | 203.1 | 235.3 | 235.3 | 235.3 |
| LS | 73 | 73 | 73 | 73 |
| LR | 79 | 79 | 79 | 79 |
| LE | 4 | 4 | 4 | 4 |
| LG | 20 | 20 | 20 | 20 |
| LW | 63 | 63 | 63 | 63 |
| RH | 30 | 30 | 30 | 30 |
| WK | 10 | 10 | 10 | 10 |
| W | 10 | 10 | 10 | 10 |
| T | 8 | 8 | 8 | 8 |
| TP | M12 Depth 25 | M12 Depth 25 | M12 Depth 25 | M12 Depth 25 |



NOTE

- 1) Dimensions are in millimeters. Actual measured values are in metric units.
- 2) Dimensions of the servo motor may be updated without prior notice.
- 3) The boxes (□) in the model names represent shaft end/brake or the number of oil seal.
- 4) The boxes (Δ) in the model names represent encoder types (Δ=1: Incremental encoder, 20-bit; Δ=2: Incremental encoder, 17-bit).

Speed-Torque Curves (T-N Curves)

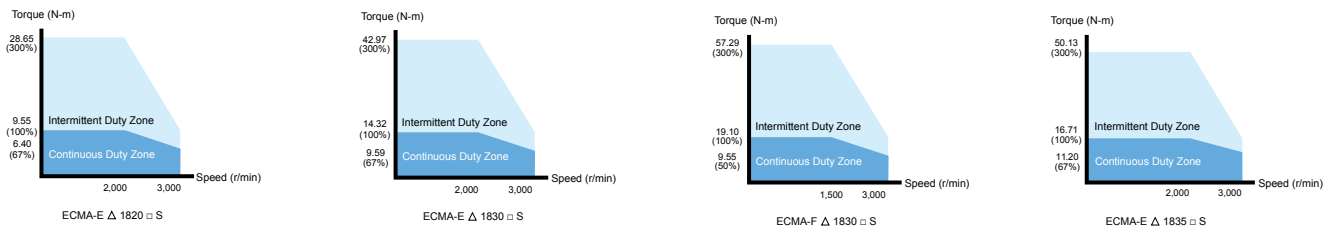

Optional Accessories

Power Cables

- 3m and 5m standard cables are available.
- Individual connectors are also provided for different demands.
- Two types are selectable: with brake and without brake.

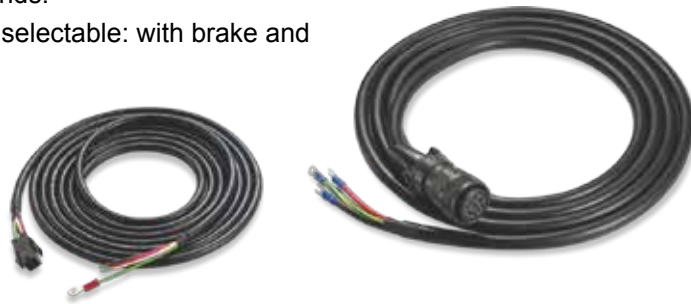

CN1 I/O Connectors

- Used to connect to external (host) controller
- Delta Part Number: ASDBCNDS0044



CN1 Convenient Connector

- Delta Part Number: ASD-IF-DS4444



Encoder Cables

- 3m and 5m standard cables are available.
- Individual connectors are also provided for different demands.





Regenerative Resistors

- Two kinds of regenerative resistors are available, 400W / 40Ω and 1kW / 20Ω.



Terminal Block Modules

- 0.5m connection cable is provided for saving on installation space.
- Delta Part Number: ASD-MDDS4444



RS-485 Connectors

- Used to connect multiple ASDA Series products by RS-485 interface through Modbus serial communication.
- Delta Part Number: ASD-CNIE0B06



ASD-Soft Software Communication Cables (for PC)

- Delta Part Number: ASD-CNUS0A08



The figures are for illustration purposes only. Actual models may differ slightly in appearance from illustrations provided.

Optional Accessories

Power Connectors

ASDBCAPW0000



ASD-CAPW1000

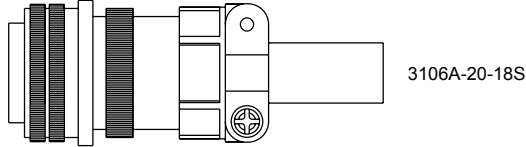

ASDBCAPW0100

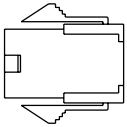

ASD-CAPW2000

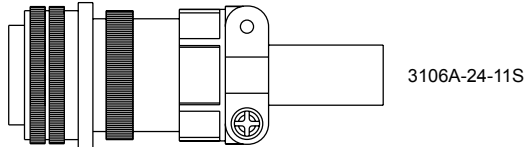

Power Cables

ASDBCAPW0203/0205

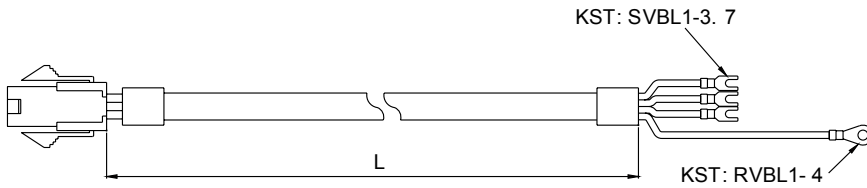

| Item | Part No. | L | |
|------|--------------|-----------|---------|
| | | mm | inch |
| 1 | ASDBCAPW0203 | 3000 ± 50 | 118 ± 2 |
| 2 | ASDBCAPW0205 | 5000 ± 50 | 197 ± 2 |

ASDBCAPW0303/0305

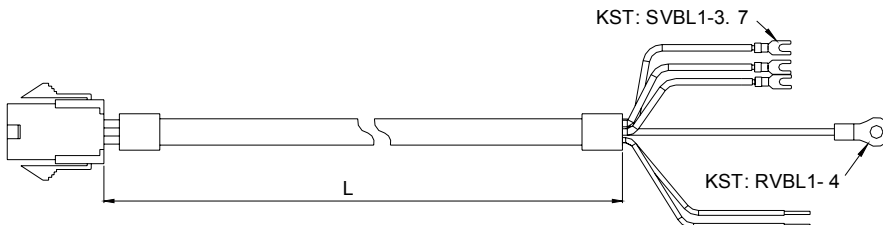

| Item | Part No. | L | |
|------|--------------|-----------|---------|
| | | mm | inch |
| 1 | ASDBCAPW0303 | 3000 ± 50 | 118 ± 2 |
| 2 | ASDBCAPW0305 | 5000 ± 50 | 197 ± 2 |

Power Cables

ASDBCAPW1203/1205

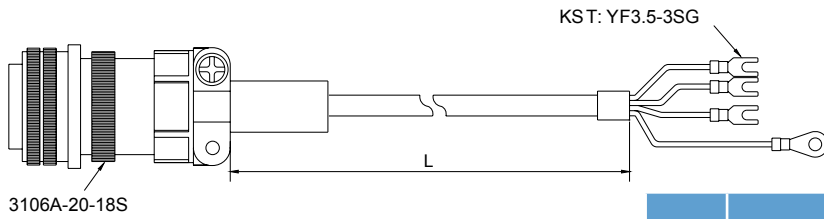

| Item | Part No. | Straight | L | |
|------|--------------|--------------|-----------|---------|
| | | | mm | inch |
| 1 | ASDBCAPW1203 | 3106A-20-18S | 3000 ± 50 | 118 ± 2 |
| 2 | ASDBCAPW1205 | 3106A-20-18S | 5000 ± 50 | 197 ± 2 |

ASDBCAPW1303/1305

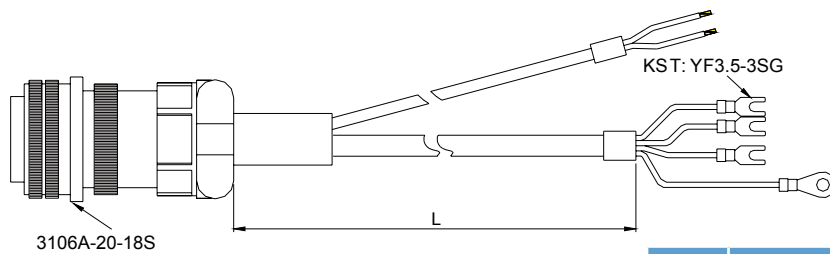

| Item | Part No. | Straight | L | |
|------|--------------|--------------|-----------|---------|
| | | | mm | inch |
| 1 | ASDBCAPW1303 | 3106A-20-18S | 3000 ± 50 | 118 ± 2 |
| 2 | ASDBCAPW1305 | 3106A-20-18S | 5000 ± 50 | 197 ± 2 |

ASD-CAPW2203/2205

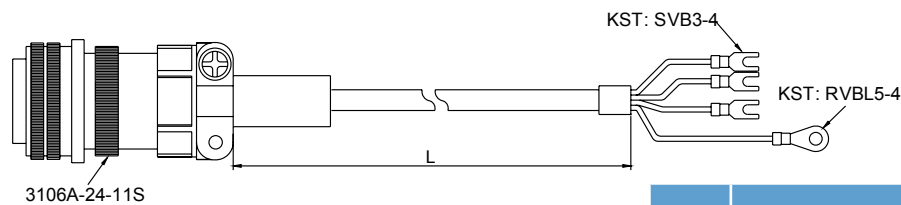

| Item | Part No. | Straight | L | |
|------|--------------|--------------|-----------|---------|
| | | | mm | inch |
| 1 | ASD-CAPW2203 | 3106A-24-11S | 3000 ± 50 | 118 ± 2 |
| 2 | ASD-CAPW2205 | 3106A-24-11S | 5000 ± 50 | 197 ± 2 |

ASD-CAPW2303/2305

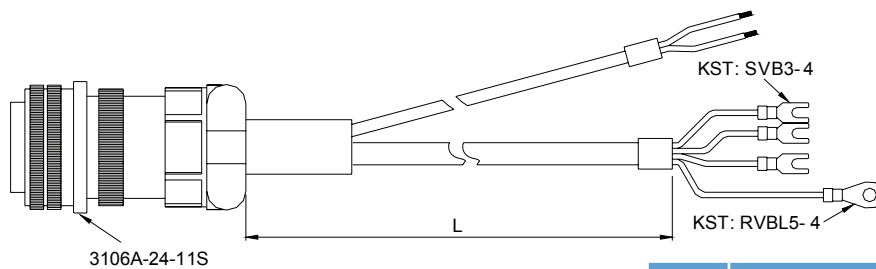

| Item | Part No. | Straight | L | |
|------|--------------|--------------|-----------|---------|
| | | | mm | inch |
| 1 | ASD-CAPW2303 | 3106A-24-11S | 3000 ± 50 | 118 ± 2 |
| 2 | ASD-CAPW2305 | 3106A-24-11S | 5000 ± 50 | 197 ± 2 |

Optional Accessories

Encoder Connectors

ASDBCAEN0000

D-SUB Connector 9P

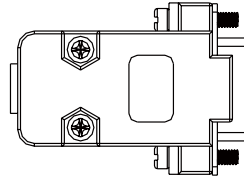

ASDBCAEN1000

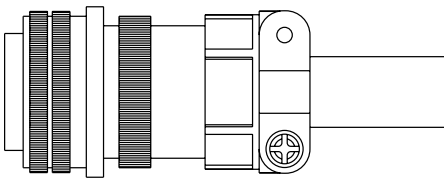

3106A-20-29S

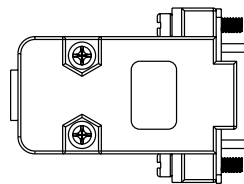

D-SUB Connector 9P

Encoder Cables

ASDBCAEN0003/0005

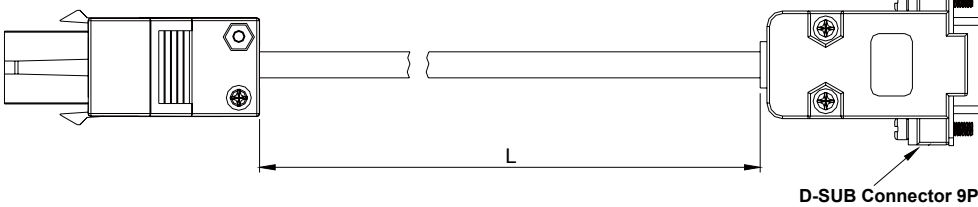

D-SUB Connector 9P

| Item | Part No. | L | |
|------|--------------|-----------|---------|
| | | mm | inch |
| 1 | ASDBCAEN0003 | 3000 ± 50 | 118 ± 2 |
| 2 | ASDBCAEN0005 | 5000 ± 50 | 197 ± 2 |

ASDBCAEN1003/1005

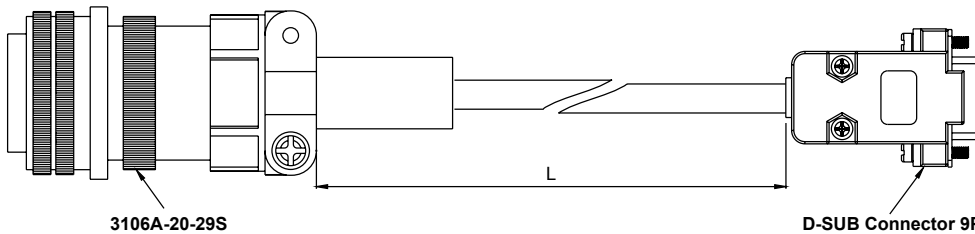

3106A-20-29S

D-SUB Connector 9P

| Item | Part No. | Straight | L | |
|------|--------------|--------------|-----------|---------|
| | | | mm | inch |
| 1 | ASDBCAEN1003 | 3106A-20-29S | 3000 ± 50 | 118 ± 2 |
| 2 | ASDBCAEN1005 | 3106A-20-29S | 5000 ± 50 | 197 ± 2 |

I/O Signal Connector

ASD-BCNDS0044

D-SUB 44 PIN PLUG

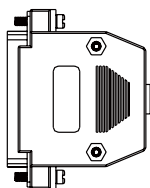

ASDBCAEN1000

D-SUB 15 PIN PLUG

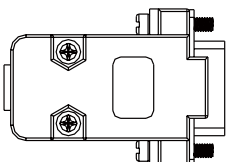

RS-485 Connector

Dimensions are in mm

ASD-CNIE0B06

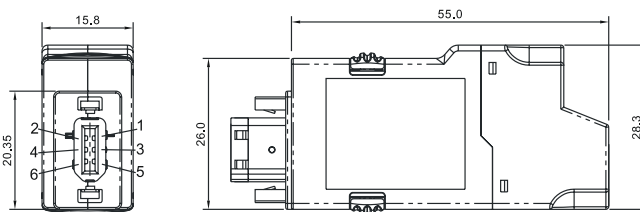

NOTE

- 1) More accessories for ASDA-B2 will be on the list.
- 2) Accessories images shown here may differ from the actual product.

Communication Cable between Drive and Computer (for PC)

Dimensions are in mm

ASD-CNUS0A08

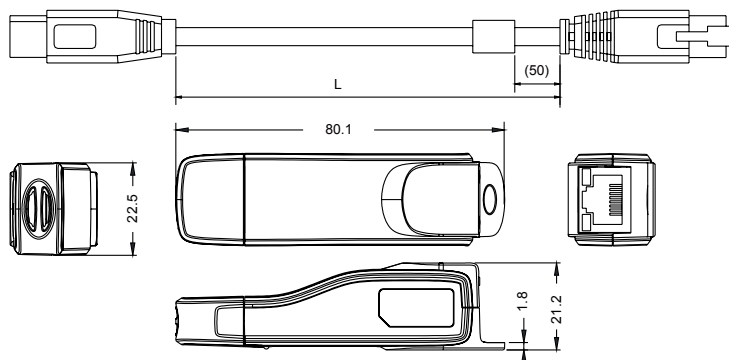

| Title | Part No. Part No. : ASD-CNUS0A08 | |
|-----------|----------------------------------|-------------------|
| Cable | L | 3000 ± 100 mm |
| | | 118 ± 4 inch |
| Connector | RJ connector | RJ-45 |
| | USB connector | A-type (USB V2.0) |

Voltage Output Cable (Analog Signal)

Dimensions are in mm

3864471800

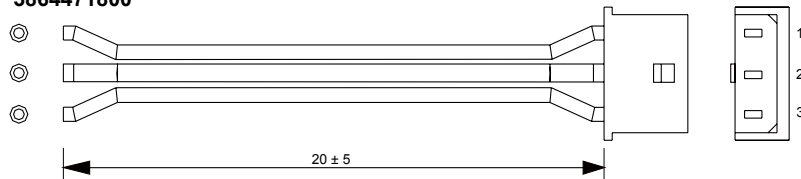

Terminal Block Module

Dimensions are in mm

ASD-MDDS4444

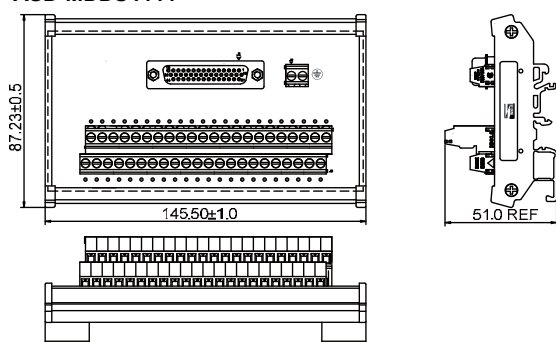

Accessories Combinations

100W Servo Drive and 100W Low Inertia Servo Motor

| Servo Drive | ASD-B2-0121-B |
|----------------------------------|-------------------|
| Low Inertia Servo Motor | ECMA-C △ 0401 □ S |
| Power Cables (Without Brake) | ASDBCAPW020X |
| Power Connectors (Without Brake) | ASDBCAPW0000 |
| Power Cables (With Brake) | ASDBCAPW030X |
| Power Connectors (With Brake) | ASDBCAPW0100 |
| Encoder Cables | ASDBCAEN000X |
| Encoder Connectors | ASDBCAEN0000 |

(X=3 indicates that the cable length is 3m; X=5 indicates that the cable length is 5m)

200W Servo Drive and 200W Low Inertia Servo Motor

| Servo Drive | ASD-B2-0221-B |
|----------------------------------|-------------------|
| Low Inertia Servo Motor | ECMA-C △ 0602 □ S |
| Power Cables (Without Brake) | ASDBCAPW020X |
| Power Connectors (Without Brake) | ASDBCAPW0000 |
| Power Cables (With Brake) | ASDBCAPW030X |
| Power Connectors (With Brake) | ASDBCAPW0100 |
| Encoder Cables | ASDBCAEN000X |
| Encoder Connectors | ASDBCAEN0000 |

(X=3 indicates that the cable length is 3m; X=5 indicates that the cable length is 5m)

400W Servo Drive and 400W Low Inertia Servo Motor

| Servo Drive | ASD-B2-0421-B |
|----------------------------------|---|
| Low Inertia Servo Motor | ECMA-C △ 0604 □ S ECMA-C △ 0804 □ 7 ECMA-CM0604PS |
| Power Cables (Without Brake) | ASDBCAPW020X |
| Power Connectors (Without Brake) | ASDBCAPW0000 |
| Power Cables (With Brake) | ASDBCAPW030X |
| Power Connectors (With Brake) | ASDBCAPW0100 |
| Encoder Cables | ASDBCAEN000X |
| Encoder Connectors | ASDBCAEN0000 |

(X=3 indicates that the cable length is 3m; X=5 indicates that the cable length is 5m)

400W Servo Drive and 400W High Inertia Servo Motor

| Servo Drive | ASD-B2-0421-B |
|----------------------------------|-------------------|
| High Inertia Servo Motor | ECMA-C △ 0604 □ H |
| Power Cables (Without Brake) | ASDBCAPW020X |
| Power Connectors (Without Brake) | ASDBCAPW0000 |
| Power Cables (With Brake) | ASDBCAPW030X |
| Power Connectors (With Brake) | ASDBCAPW0100 |
| Encoder Cables | ASDBCAEN000X |
| Encoder Connectors | ASDBCAEN0000 |

(X=3 indicates that the cable length is 3m; X=5 indicates that the cable length is 5m)

400W Servo Drive and 500W Medium Inertia Servo Motor

| Servo Drive | ASD-B2-0421-B |
|------------------------------|-------------------|
| Medium Inertia Servo Motor | ECMA-E △ 1305 □ S |
| Power Cables (Without Brake) | ASDBCAPW120X |
| Power Cables (With Brake) | ASDBCAPW130X |
| Power Connectors | ASD-CAPW1000 |
| Incremental Encoder Cables | ASDBCAEN100X |
| Encoder Connectors | ASDBCAEN1000 |

(X=3 indicates that the cable length is 3m; X=5 indicates that the cable length is 5m)

400W Servo Drive and 300W High Inertia Servo Motor

| Servo Drive | ASD-B2-0421-B |
|------------------------------|-------------------|
| High Inertia Servo Motor | ECMA-G △ 1303 □ S |
| Power Cables (Without Brake) | ASDBCAPW120X |
| Power Cables (With Brake) | ASDBCAPW130X |
| Power Connectors | ASD-CAPW1000 |
| Encoder Cables | ASDBCAEN100X |
| Encoder Connectors | ASDBCAEN1000 |

(X=3 indicates that the cable length is 3m; X=5 indicates that the cable length is 5m)

750W Servo Drive and 600W High Inertia Servo Motor

| Servo Drive | ASD-B2-0721-B |
|------------------------------|------------------------------------|
| High Inertia Servo Motor | ECMA-G △ 1306 □ S ECMA-GM1306PS |
| Power Cables (Without Brake) | ASDBCAPW120X |
| Power Cables (With Brake) | ASDBCAPW130X |
| Power Connectors | ASD-CAPW1000 |
| Encoder Cables | ASDBCAEN100X |
| Encoder Connectors | ASDBCAEN1000 |

(X=3 indicates that the cable length is 3m; X=5 indicates that the cable length is 5m)

750W Servo Drive and 750W Low Inertia Servo Motor

| Servo Drive | ASD-B2-0721-B |
|----------------------------------|---|
| Low Inertia Servo Motor | ECMA-C △ 0807 □ S ECMA-C △ 0907 □ 7 ECMA-CM0807PS |
| Power Cables (Without Brake) | ASDBCAPW020X |
| Power Connectors (Without Brake) | ASDBCAPW0000 |
| Power Cables (With Brake) | ASDBCAPW030X |
| Power Connectors (With Brake) | ASDBCAPW0100 |
| Encoder Cables | ASDBCAEN000X |
| Encoder Connectors | ASDBCAEN0000 |

(X=3 indicates that the cable length is 3m; X=5 indicates that the cable length is 5m)

Accessories Combinations

750W Servo Drive and 750W High Inertia Servo Motor

| Servo Drive | ASD-B2-0721-B |
|----------------------------------|-------------------|
| High Inertia Servo Motor | ECMA-C △ 0807 □ H |
| Power Cables (Without Brake) | ASDBCAPW020X |
| Power Connectors (Without Brake) | ASDBCAPW0000 |
| Power Cables (With Brake) | ASDBCAPW030X |
| Power Connectors (With Brake) | ASDBCAPW0100 |
| Encoder Cables | ASDBCAEN000X |
| Encoder Connectors | ASDBCAEN0000 |

(X=3 indicates that the cable length is 3m; X=5 indicates that the cable length is 5m)

1kW Servo Drive and 850W Low Inertia Servo Motor

| Servo Drive | ASD-B2-1021-B |
|------------------------------|-------------------|
| Low Inertia Servo Motor | ECMA-F △ 1308 □ S |
| Power Cables (Without Brake) | ASDBCAPW120X |
| Power Cables (With Brake) | ASDBCAPW130X |
| Power Connectors | ASD-CAPW1000 |
| Encoder Cables | ASDBCAEN100X |
| Encoder Connectors | ASDBCAEN1000 |

(X=3 indicates that the cable length is 3m; X=5 indicates that the cable length is 5m)

1kW Servo Drive and 1kW Low Inertia Servo Motor

| Servo Drive | ASD-B2-1021-B |
|------------------------------|-------------------|
| Low Inertia Servo Motor | ECMA-C △ 1010 □ S |
| Power Cables (Without Brake) | ASDBCAPW120X |
| Power Cables (With Brake) | ASDBCAPW130X |
| Power Connectors | ASD-CAPW1000 |
| Encoder Cables | ASDBCAEN100X |
| Encoder Connectors | ASDBCAEN1000 |

(X=3 indicates that the cable length is 3m; X=5 indicates that the cable length is 5m)

1kW Servo Drive and 1kW Low Inertia Servo Motor

| Servo Drive | ASD-B2-1021-B |
|----------------------------------|-------------------|
| Low Inertia Servo Motor | ECMA-C △ 0910 □ S |
| Power Cables (Without Brake) | ASDBCAPW020X |
| Power Connectors (Without Brake) | ASDBCAPW0000 |
| Power Cables (With Brake) | ASDBCAPW030X |
| Power Connectors (With Brake) | ASDBCAPW0100 |
| Incremental Encoder Cables | ASDBCAEN000X |
| Encoder Connectors | ASDBCAEN0000 |

(X=3 indicates that the cable length is 3m; X=5 indicates that the cable length is 5m)

1kW Servo Drive and 1kW Medium Inertia Servo Motor

| Servo Drive | ASD-B2-1021-B |
|------------------------------|----------------------------------|
| Medium Inertia Servo Motor | ECMA-E Δ 1310 \square S |
| Power Cables (Without Brake) | ASDBCAPW120X |
| Power Cables (With Brake) | ASDBCAPW130X |
| Power Connectors | ASD-CAPW1000 |
| Encoder Cables | ASDBCAEN100X |
| Encoder Connectors | ASDBCAEN1000 |

(X=3 indicates that the cable length is 3m; X=5 indicates that the cable length is 5m)

1kW Servo Drive and 900W High Inertia Servo Motor

| Servo Drive | ASD-B2-1021-B |
|------------------------------|---|
| High Inertia Servo Motor | ECMA-G Δ 1309 \square S ECMA-GM1309PS |
| Power Cables (Without Brake) | ASDBCAPW120X |
| Power Cables (With Brake) | ASDBCAPW130X |
| Power Connectors | ASD-CAPW1000 |
| Encoder Cables | ASDBCAEN100X |
| Encoder Connectors | ASDBCAEN1000 |

(X=3 indicates that the cable length is 3m; X=5 indicates that the cable length is 5m)

1.5kW Servo Drive and 1.5kW Medium Inertia Servo Motor

| Servo Drive | ASD-B2-1521-B |
|------------------------------|----------------------------------|
| Medium Inertia Servo Motor | ECMA-E Δ 1315 \square S |
| Power Cables (Without Brake) | ASDBCAPW120X |
| Power Cables (With Brake) | ASDBCAPW130X |
| Power Connectors | ASD-CAPW1000 |
| Encoder Cables | ASDBCAEN100X |
| Encoder Connectors | ASDBCAEN1000 |

(X=3 indicates that the cable length is 3m; X=5 indicates that the cable length is 5m)

2kW Servo Drive and 2kW Low Inertia Servo Motor

| Servo Drive | ASD-B2-2023-B |
|------------------------------|----------------------------------|
| Low Inertia Servo Motor | ECMA-C Δ 1020 \square S |
| Power Cables (Without Brake) | ASDBCAPW120X |
| Power Cables (With Brake) | ASDBCAPW130X |
| Power Connectors | ASDBCAPW1000 |
| Encoder Cables | ASDBCAEN100X |
| Encoder Connectors | ASDBCAEN1000 |

(X=3 indicates that the cable length is 3m; X=5 indicates that the cable length is 5m)

Accessories Combinations

2kW Servo Drive and 2kW Medium Inertia Servo Motor

| Servo Drive | ASD-B2-2023-B |
|------------------------------|-------------------------------------|
| Medium Inertia Servo Motor | ECMA-E \triangle 1320 \square S |
| Power Cables (Without Brake) | ASDBCAPW120X |
| Power Cables (With Brake) | ASDBCAPW130X |
| Power Connectors | ASD-CAPW1000 |
| Encoder Cables | ASDBCAEN100X |
| Encoder Connectors | ASDBCAEN1000 |

(X=3 indicates that the cable length is 3m; X=5 indicates that the cable length is 5m)

2kW Servo Drive and 2kW Medium Inertia Servo Motor

| Servo Drive | ASD-B2-2023-B |
|------------------------------|-------------------------------------|
| Medium Inertia Servo Motor | ECMA-E \triangle 1820 \square S |
| Power Cables (Without Brake) | ASD-CAPW220X |
| Power Cables (With Brake) | ASD-CAPW230X |
| Power Connectors | ASD-CAPW2000 |
| Encoder Cables | ASDBCAEN100X |
| Encoder Connectors | ASDBCAEN1000 |

(X=3 indicates that the cable length is 3m; X=5 indicates that the cable length is 5m)

2kW Servo Drive and 1.3kW Medium High Inertia Servo Motor

| Servo Drive | ASD-B2-2023-B |
|---------------------------------|-------------------------|
| Medium High Inertia Servo Motor | ECMA-F11313 \square S |
| Power Cables (Without Brake) | ASDBCAPW120X |
| Power Cables (With Brake) | ASDBCAPW130X |
| Power Connectors | ASD-CAPW1000 |
| Encoder Cables | ASDBCAEN100X |
| Encoder Connectors | ASDBCAEN1000 |

(X=3 indicates that the cable length is 3m; X=5 indicates that the cable length is 5m)

2kW Servo Drive and 1.8kW Medium High Inertia Servo Motor

| Servo Drive | ASD-B2-2023-B |
|---------------------------------|-------------------------|
| Medium High Inertia Servo Motor | ECMA-F11318 \square S |
| Power Cables (Without Brake) | ASDBCAPW120X |
| Power Cables (With Brake) | ASDBCAPW130X |
| Power Connectors | ASD-CAPW1000 |
| Encoder Cables | ASDBCAEN100X |
| Encoder Connectors | ASDBCAEN1000 |

(X=3 indicates that the cable length is 3m; X=5 indicates that the cable length is 5m)

3kW Servo Drive and 3kW Low Inertia Servo Motor

| Servo Drive | ASD-B2-3023-B |
|------------------------------|-------------------------------------|
| Low Inertia Servo Motor | ECMA-C \triangle 1330 \square 4 |
| Power Cables (Without Brake) | ASDBCAPW120X |
| Power Cables (With Brake) | ASDBCAPW130X |
| Power Connectors | ASD-CAPW1000 |
| Encoder Cables | ASDBCAEN100X |
| Encoder Connectors | ASDBCAEN1000 |

(X=3 indicates that the cable length is 3m; X=5 indicates that the cable length is 5m)

3kW Servo Drive and 3kW Medium Inertia Servo Motor

| Servo Drive | ASD-B2-3023-B |
|------------------------------|-------------------------------------|
| Medium Inertia Servo Motor | ECMA-E \triangle 1830 \square S |
| Power Cables (Without Brake) | ASD-CAPW220X |
| Power Cables (With Brake) | ASD-CAPW230X |
| Power Connectors | ASD-CAPW2000 |
| Encoder Cables | ASDBCAEN100X |
| Encoder Connectors | ASDBCAEN1000 |

(X=3 indicates that the cable length is 3m; X=5 indicates that the cable length is 5m)

3kW Servo Drive and 3.5kW Medium Inertia Servo Motor

| Servo Drive | ASD-B2-3023-B |
|------------------------------|-------------------------------------|
| Medium Inertia Servo Motor | ECMA-E \triangle 1835 \square S |
| Power Cables (Without Brake) | ASD-CAPW220X |
| Power Cables (With Brake) | ASD-CAPW230X |
| Power Connectors | ASD-CAPW2000 |
| Encoder Cables | ASDBCAEN100X |
| Encoder Connectors | ASDBCAEN1000 |

(X=3 indicates that the cable length is 3m; X=5 indicates that the cable length is 5m)

3kW Servo Drive and 3kW Medium High Inertia Servo Motor

| Servo Drive | ASD-B2-3023-B |
|---------------------------------|-------------------------------------|
| Medium High Inertia Servo Motor | ECMA-F \triangle 1830 \square S |
| Power Cables (Without Brake) | ASD-CAPW220X |
| Power Cables (With Brake) | ASD-CAPW230X |
| Power Connectors | ASD-CAPW2000 |
| Encoder Cables | ASDBCAEN100X |
| Encoder Connectors | ASDBCAEN1000 |

(X=3 indicates that the cable length is 3m; X=5 indicates that the cable length is 5m)

Other Accessories (for ASDA-B2 Series all models)

| Description | Delta Part Number |
|--|-------------------|
| Communication Cable between Servo Drive and Computer | ASD-CARS0003 |
| Regenerative Resistor 400W 100 Ω | BR400W040 |
| Regenerative Resistor 1kW 1000 Ω | BR1K0W020 |

MEXICO BRANCH OFFICE

Roberto Diaz No. 401
Ciudad Industrial
Aguascalientes, Ags.
México
20290



USA BRANCH OFFICE

4ManPro®
708 Main St.
10th Floor
Houston, Tx, USA
77002

4ManPro@4ManPro.com
(449) 171 3420
www.4ManPro.com/SPA/

4ManPro-USA@4ManPro.com
+1 (832) 871 5022
www.4ManPro.com/ENG/

*Elements For
Manufacturing Processes*



DELTA